



2018 NISSANCONNECT®

OWNER'S MANUAL



Zero Emission

For your safety, read carefully and keep in this vehicle.

NISSAN CONSUMER AFFAIRS DEPARTMENT

For assistance or inquiries about the NISSAN Navigation System, NISSAN warranty, service or general questions, contact the NISSAN Consumer Affairs Department at:

For U.S. customers

Nissan North America, Inc.
Consumer Affairs Department
P.O. Box 685003
Franklin, TN 37068-5003
1-877-NOGASEV
1-877-664-2738

For Canadian customers

Nissan Canada Inc.
5290 Orbitor Drive
Mississauga, Ontario L4W 4Z5
1-800-387-0122

NISSAN NAVIGATION SYSTEM HELPDESK CONTACT INFORMATION

To order updated map data, contact the NISSAN NAVIGATION SYSTEM HELPDESK at:

- E-MAIL: nissan-navi-info@here.com
- WEBSITE: www.NissanNavigation.com
- PHONE: 1-888-661-9995

NISSANCONNECT® EV AND SERVICES CUSTOMER SERVICE

- WEBSITE for U.S. customers:
www.NissanUSA.com/connect
- WEBSITE for Canadian customers:
www.Nissan.ca/NissanConnect (English)
www.Nissan.ca/NissanConnect/fr (French)
- E-MAIL:
nissanownerservices@nissan-usa.com
- PHONE:
1-877-664-2738
- HOURS:
Mon-Sat, 8:00 AM to 12:00 AM (Eastern Standard Time)

FOREWORD

Thank you for purchasing a NISSAN vehicle.

This user's manual is for NissanConnect® with Navigation, EV and Services offered in your NISSAN vehicle.

Operation instructions for the following systems are included in this manual.

- EV-specific functions
- Audio
- Hands-Free Phone
- NissanConnect® EV and Services
- Apple CarPlay™
- Android Auto™
- Navigation
- Voice recognition
- Information and settings viewable on the system

Please read this manual carefully to ensure safe operation of NissanConnect® with Navigation, EV and Services.

- Because of possible specification changes and optional equipment, some sections of this manual may not apply to your vehicle.

- All information, specifications and illustrations in this manual are those in effect at the time of printing. NISSAN reserves the right to change specifications or design at any time without notice.
- Do not remove this manual from the vehicle when selling this vehicle. The next user of the system may need the manual.

Table of Contents

0 Introduction

How to use this manual....	0-2
Safety information.....	0-3
Trademarks.....	0-4
Regulatory information	0-6
Licenses.....	0-8

IT System overview

System features	IT-2
-----------------------	------

1 Getting started

Control buttons and touch screen display	1-2
Starting system.....	1-6
Basic operation.....	1-7
System settings.....	1-15

2 Unique EV functions

Zero Emission menu screen.....	2-2
--------------------------------	-----

Displaying estimated driving range and charging station information.....	2-3
Energy usage information display	2-8
Unique EV function settings.....	2-9

3 Navigation

Safety information.....	3-3
Map operation	3-3
Setting destination.....	3-16
Route guidance.....	3-31
Viewing traffic information.....	3-49
Storing a location/route.....	3-52
Navigation settings.....	3-60

4 Audio system

Audio operation precautions	4-2
Names and functions of audio control buttons.....	4-8
Audio operations	4-9
Audio settings.....	4-26

5 NissanConnect® EV and Services

Telematics overview	5-2
NissanConnect® EV and Services	5-4
NissanConnect® EV and Services menu.....	5-11
Emergency support.....	5-15
NissanConnect® EV and Services settings.....	5-17
Error message on communication.....	5-21

6 Viewing information

Information menu.....	6-2
SiriusXM Travel Link.....	6-7
Apple CarPlay™ (if so equipped).....	6-9
Android Auto™	6-12

7 Hands-Free Phone

Bluetooth® Hands-Free Phone System	7-2
--	-----

8 Voice recognition

Voice recognition	8-2
-------------------------	-----

9 General system information

Current vehicle location....	9-2
Route calculation.....	9-6
Route guidance.....	9-8
Map data	9-9

How to handle display	9-13
How to handle the SD card.....	9-14
How to handle USB memory.....	9-15

10 Troubleshooting guide

Customer assistance.....	10-2
System unit.....	10-3
Unique EV functions.....	10-5
Audio system.....	10-8
Bluetooth® Hands-Free Phone System	10-15
NissanConnect® EV and Services	10-18
Navigation	10-19
Voice recognition	10-26
Apple CarPlay™ (if so equipped).....	10-29
Android Auto™	10-30

0 Introduction

How to use this manual	0-2	Regulatory information	0-6
For safe operation	0-2	Laser product	0-6
Reference symbols	0-2	Bluetooth® devices	0-6
Screen illustrations	0-2	Licenses	0-8
Safety information	0-3	Telematic Control Unit Gen2K	0-8
Trademarks	0-4		

0. Introduction

HOW TO USE THIS MANUAL

This manual uses special words, symbols, icons and illustrations organized by function.

Please refer to the following items and familiarize yourself with them.

FOR SAFE OPERATION



WARNING

This is used to indicate the presence of a hazard that could cause death or serious personal injury. To avoid or reduce the risk, the procedures must be followed precisely.



CAUTION

This is used to indicate the presence of a hazard that could cause minor or moderate personal injury or damage to your vehicle. To avoid or reduce the risk, the procedures must be followed carefully.



NOTE:

Indicates items that help you understand and maximize the performance of your vehicle. If ignored, they may lead to a malfunction or poor performance.

REFERENCE SYMBOLS



INFO:

This indicates information that is necessary for efficient use of your vehicle or accessories.



Reference page:

This indicates the title and page that you should refer to.

< >:

Indicates a button on the control panel.

[]:

This indicates a key/item displayed on the screen.



Voice Command:

This indicates an operation by voice command.

SCREEN ILLUSTRATIONS

- The illustrations in this manual are representatives of various models and may not be identical with the design and specifications of your vehicle.
- Icons and menu items displayed on the screen may be abbreviated or omitted from the screen illustrations when appropriate. The omitted icons and menu items are described as dotted lines as illustrated.

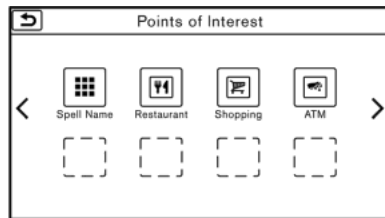
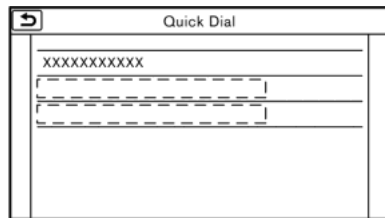

SAFETY INFORMATION

This system is primarily designed to help you support pleasant driving as outlined in this manual. However, you, the driver, must use the system safely and properly. Information and the availability of services may not always be up to date. The system is not a substitute for safe, proper and legal driving.

Before using the system, please read the following safety information. Always use the system as outlined in this manual.



WARNING

- To operate the system, first park the vehicle in a safe location and set the parking brake. Operating the system while driving can distract the driver and may result in a serious accident.
- Exercise extreme caution at all times so full attention may be given to vehicle operation. If the system doesn't respond immediately, please be patient and keep your eyes on the road. Inattentive driving may lead to a crash resulting in serious injuries or death.

- Do not rely on route guidance alone. Always be sure that all driving maneuvers are legal and safe in order to avoid accidents.
- Do not disassemble or modify this system. If you do, it may result in accidents, fire or electrical shock.
- If you notice any foreign objects in the system hardware, spill liquid on the system or notice smoke or a smell coming from it, stop using the system immediately and contact a NISSAN certified LEAF dealer. Ignoring such conditions may lead to accidents, fire or electrical shock.



CAUTION

- Some jurisdictions may have laws limiting the use of video screens while driving. Use this system only where it is legal to do so.
- Extreme temperature conditions [below -4°F (-20°C) and above 158°F (70°C)] could affect the performance of the system.
- The display screen may break if it is hit with a hard or sharp object. If

the display screen breaks, do not touch it. Doing so could result in an injury.



NOTE:

- Do not keep the system running with the READY to drive indicator light OFF. Doing so may discharge the 12-volt battery. When you use this system, always make sure the READY to drive indicator light is ON.
- Completing the NissanConnect® EV and Services registration is necessary to use NissanConnect® EV and Services related functions. NissanConnect® EV and Services may not be available in some regions.
- To check the Li-ion battery charging status or to use the remote heater and air conditioner using an internet enabled smart phone or personal computer, the following conditions must be met:
 - The vehicle must be located in a cellular phone or smart phone coverage area.
 - The internet enabled cellular phone or smart phone must be located in a cellular phone or

O. Introduction

smart phone coverage area.

- The computer must be connected to the internet.
- A cellular phone must be used to communicate with the vehicle.
- A cellular phone capable of text messaging must be used to receive text message regarding vehicle charge status.
- When the remote heater and air conditioner is set, the system operates the heater and air conditioner to adjust the in-cabin temperature to a set temperature.
- When the charge connector is disconnected from the vehicle, the heater and air conditioner operates using vehicle Li-ion battery electric power.
- If the remote heater and air conditioner function and Li-ion battery charging are performed at the same time, Li-ion battery charging will take longer than usual due to the power used to heat or cool the vehicle.
- Certain remote functions require a compatible smart phone, which is not included with vehicle.
- NissanConnect® EV and Services information system features are included through a subscription service which requires owner consent to activate. The subscription must be active to use these features.
- NissanConnect® EV and Services communications may be received at a verified e-mail address or by SMS/text messaging-enabled cellular phone.
- Standard text rates and/or data usage may apply depending on your carrier.

TRADEMARKS

Windows® and Windows Media® are registered trademarks or trademarks of Microsoft Corporation in the United States of America and/or other countries.

Windows Media Player:

This product is protected by certain intellectual property right of Microsoft. Use or distribution of such technology outside of this product is prohibited without a license from Microsoft.



"Made for iPod" and "Made for iPhone" mean that an electronic accessory has been designed to connect specifically to iPod® or iPhone®, respectively, and has been certified by the developer to meet Apple performance standards. Apple is not responsible for the operation of this device or its compliance with safety and regulatory standards. Please note that the use of this accessory with iPod® or iPhone® may affect wireless performance.

Apple, the Apple logo, iPhone®, iPod®, iPod classic®, iPod nano®, and iPod touch® are trademarks of Apple Inc., registered in the U.S. and other countries. Lightning is a trademark of Apple Inc. App Store is a

service mark of Apple Inc.



The Bluetooth® word mark and logos are registered trademarks owned by Bluetooth SIG, Inc. and any use of such marks by Clarion Co., Ltd. is under license. Other trademarks and trade names are those of their respective owners.



HD Radio Technology manufactured under license from iBiquity Digital Corporation. U.S. and Foreign Patents. For patents see <http://patents.dts.com/>. HD Radio and the HD, HD Radio, and "ARC" logos are registered trademarks or trademarks of iBiquity Digital Corporation in the United States and/or other countries.



SiriusXM® services require a subscription after trial period and are sold separately

or as a package. The satellite service is available only in the 48 contiguous USA and DC. SiriusXM® satellite service is also available in Canada; see www.siriusxm.ca.



SiriusXM Satellite Radio and SiriusXM Traffic subscriptions are sold separately or as a package, and are continuous until you call SiriusXM to cancel. See SiriusXM Customer Agreement for complete terms at www.siriusxm.com (U.S.)

www.siriusxm.ca (Canada)

SiriusXM Traffic is available in select markets. For more information, call Listener Care at

1-877-447-0011 (U.S.)

1-877-438-9677 (Canada)

or visit

www.siriusxm.com/traffic (U.S.)

www.siriusxm.ca/siriusxm-traffic-services/siriusxm-traffic (English, Canada)

www.siriusxm.ca/fr/services-siriusxm-traffic/siriusxm-traffic (French, Canada)

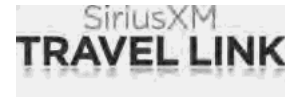

SiriusXM Satellite Radio and SiriusXM Travel Link subscriptions are sold separately or as a package, and are continuous until you call SiriusXM to cancel. See SiriusXM Customer Agreement for complete terms at

www.siriusxm.com (U.S.)

www.siriusxm.ca (Canada)

SiriusXM Travel Link is available in select markets. For more information, call Listener Care at

1-877-447-0011 (U.S.)

1-877-438-9677 (Canada)

or visit

www.siriusxm.com/travellink (U.S.)

www.siriusxm.ca/siriusxm-traffic-services/siriusxm-traffic (English, Canada)

www.siriusxm.ca/fr/services-siriusxm-traffic/siriusxm-traffic (French, Canada)

App StoreSM

Apple and the Apple logo are trademarks of Apple Inc., registered in the U.S. and other countries. App Store is a service mark of Apple Inc.

O. Introduction

Siri®

Siri® is a trademark of Apple Inc., registered in the U.S. and other countries.

Apple CarPlay™

Apple CarPlay™ is a trademark of Apple Inc., registered in the U.S. and other countries.

Google Play™

Google, Google Play are trademarks of Google Inc.

Google™

Google is a trademark of Google Inc.

REGULATORY INFORMATION

LASER PRODUCT

This NissanConnect® with Navigation, EV and Services is certified as a Class 1 laser product.

The system complies with DHHS Rules 21 CFR Chapter 1, Subchapter J.



WARNING

- **Do not disassemble or modify this system. There are no user serviceable parts in the system.**
- **If maintenance, adjustments and operations other than those specified in this manual are attempted, injury due to laser radiation and exposure could occur.**

BLUETOOTH® DEVICES

FCC Regulatory information (for U.S.)

FCC ID: WY2QY8600

NOTE

This device complies with part 15 of the FCC Rules. Operation is subject to the following two conditions: (1) This device may not cause harmful interference, and (2) this device must accept any interference received, including interference that may cause undesired operation.

FCC WARNING

Changes or modifications not expressly approved by the party responsible for compliance could void the user's authority to operate the equipment.

CAUTION: Radio Frequency Radiation Exposure

This equipment complies with FCC radiation exposure limits set forth for uncontrolled environment and meets the FCC radio frequency (RF) Exposure Guidelines in Supplement C to OET65. This equipment has very low levels of RF energy that it deemed to comply without maximum permissive exposure evaluation (MPE). But it is desirable that it should be installed and operated with at least 20 cm and

more between the radiator and person's body (excluding extremities: hands, wrists, feet and ankles).

Co-location: This transmitter must not be co-located or operated in conjunction with any other antenna or transmitter.

IC Regulatory information (for Canada)

The antenna cannot be removed (and changed) by user.

This device complies with Industry Canada license-exempt RSS standard(s). Operation is subject to the following two conditions: (1) This device may not cause interference, and (2) this device must accept any interference, including interference that may cause undesired operation of the device.

CAUTION: Radio Frequency Radiation Exposure

This equipment complies with IC radiation exposure limits set forth for uncontrolled environment and meets RSS-102 of the IC radio frequency (RF) Exposure rules. This equipment has very low levels of RF energy that it deemed to comply without maximum permissive exposure evaluation (MPE). But it is desirable that it should be installed and operated with at least 20 cm and more between the radiator and

person's body (excluding extremities: hands, wrists, feet and ankles.)

Co-location: This transmitter must not be co-located or operated in conjunction with any other antenna or transmitter.

This Class B digital apparatus meets all requirements of the Canadian Interference-Causing Equipment Regulations.

For Quebec :

L'antenne ne peut être enlevée (et modifiée) par l'utilisateur.

NOTE

Le présent appareil est conforme aux CNR d'Industrie Canada applicables aux appareils radio exempts de licence. L'exploitation est autorisée aux deux conditions suivantes : (1) l'appareil ne doit pas produire de brouillage, et (2) l'utilisateur de l'appareil doit accepter tout brouillage radioélectrique subi, même si le brouillage est susceptible d'en compromettre le fonctionnement.

ATTENTION : l'exposition aux rayonnements radiofréquence

Cet équipement est conforme aux limites d'exposition aux radiations IC définies pour un environnement non contrôlé et satisfait RSS-102 de la fréquence radio (RF) IC règles d'exposition. Cet équipement

présente des niveaux très faibles d'énergie RF réputé conforme sans évaluation de l'exposition maximale permissive (MPE). Mais il est souhaitable qu'il devrait être installé et fonctionner avec au moins 20 cm entre le radiateur et le corps de la personne (à l'exception des membres: Mains, poignets, pieds et chevilles).

Co-localisation : Cet émetteur ne doit pas être co-implantés ou exploités en conjonction avec une autre antenne ou un autre émetteur.

0. Introduction

LICENSES

TELEMATIC CONTROL UNIT GEN2K

A. INTRODUCTION

This product Telematic Control Unit Gen2K incorporates the following software:

- (1) the software developed by, or developed for, Ficosa International, S.A. ("Ficosa"),
- (2) the software owned by third party and licensed to Ficosa,
- (3) the software licensed under the GNU GENERAL PUBLIC LICENSE, Version 2 ("GPL"),
- (4) the software licensed under the GNU LIBRARY GENERAL PUBLIC LICENSE, Version 2.0 or the GNU LESSER GENERAL PUBLIC LICENSE, Version 2.1 (collectively "LGPL"), the Mozilla Public license v2 ("MPL"), the GPL-2.0 license with-OpenSSL-exception ("GPLOpenSSL") and GNU GENERAL PUBLIC LICENSE, Version 3 with GCC exception (together with the GPL software, jointly "Copyleft Software"), and/or
- (5) open sourced software licensed under terms and conditions other than Copyleft

Software.

For the software classified as (3) or (4) above, a copy of the license text is included with the source code in the URL indicated below, and please also refer to the terms and conditions of Copyleft Software licenses at the websites listed below:

GPL: <http://www.gnu.org/licenses/old-licenses/gpl-2.0.html> and <https://www.gnu.org/licenses/gpl-3.0.en.html>

LGPL: <http://www.gnu.org/licenses/old-licenses/lgpl-2.1.html> and <http://www.gnu.org/licenses/old-licenses/lgpl-2.0.html>

MPL: <https://www.mozilla.org/en-US/MPL/2.0/>

GPL-2.0-with-OpenSSL-exception: <https://gitlab.com/cryptsetup/cryptsetup/blob/master/COPYING>

GPLv3 GCC Exception: <https://www.gnu.org/licenses/gcc-exception-3.1.en.html>

The software classified as (3) and (4) above are copyrighted by multiple people. Please refer to the websites below regarding the copyright notices of those people. <https://www.ficosa.com/software/>

[opensource/](#)

The software licensed under the licenses indicated in (3) and (4) above ("Copyleft Software") is distributed in the hope that it will be useful, but WITHOUT ANY WARRANTY, without even the implied warranty of MERCHANTABILITY or FITNESS FOR A PARTICULAR PURPOSE.

For at least three (3) years from delivery of a device embedding the above product, Ficosa will give to any third party who contacts us at the Contact Information provided below, for a charge no more than our cost of physically performing source code distribution, a complete machine-readable copy of the source code corresponding to the Copyleft Software indicated above. When requesting this source code, please specify Product: Telematic Control Unit Gen2K and version Cx9.

Furthermore, source code and licenses corresponding to the Copyleft Software listed above is freely available to you and any member of the public at the website listed below:

<https://www.ficosa.com/software/opensource/>

[Contact Information]

For enquiries about open source software at FICOSA, please contact Ficosas Compliance Officer by email: FOSS@ficosas.com

Please note that we are unable to answer any queries regarding source code details, etc.

In addition, it is necessary for end users to provide their own internet connection.

The end user is responsible for any connection or line charges incurred through browsing websites or downloading.

B. LICENSING AND COPYRIGHT NOTICE INFORMATION

The software classified as (5) above contains various open sourced software ("OSS") listed in the below website. Please see the website indicated next for the terms and conditions of the licenses (OSS Licenses) and other information regarding the OSS contained in this Product:
<https://www.ficosas.com/software/opensource/>

O. Introduction

MEMO

IT System overview

System features	IT-2
Unique EV functions	IT-2
Telematics service	IT-3



IT. System overview

SYSTEM FEATURES

UNIQUE EV FUNCTIONS

In addition to the conventional navigation functions, the NissanConnect® with Navigation, EV and Services also offers specific support for driving an EV.

Menus specific to EV can be accessed from the Zero Emission menu screen.

 "Zero Emission menu screen"
(page 2-2)



CAUTION

Charging station information may not be detailed in all areas or reflect current charging station locations. For up to date information about charging stations, such as business hours or charging equipment, NISSAN recommends that you directly access the information on your own. Additionally, always check the remaining amount of battery charge and set a reasonable driving schedule.

Driving range display

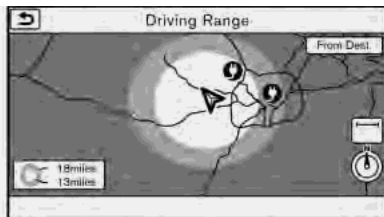

Touch [Driving Range] in the Zero Emission menu.

 "Zero Emission menu screen"
(page 2-2)

You can display the estimated one way range that the vehicle can be driven from the current location based on the amount of remaining battery charge. When a destination or a waypoint has been set, the driving area will be displayed with the destination or waypoint in the center.

 "Displaying estimated driving range"
(page 2-3)

Charging stations located within the driving area will also be displayed. By moving the map, you can set a charging station as a destination or waypoint.

 "Setting a charging station as destination" (page 2-4)

Charging station information



NOTE:

Charging stations that have been searched for using this function are not necessarily equipped with devices that can be used to charge a LEAF. Be sure to confirm this in advance before setting a charging station as the destination.



INFO:

Charging station information around the registered home location is updated monthly to add newly installed charging station locations.

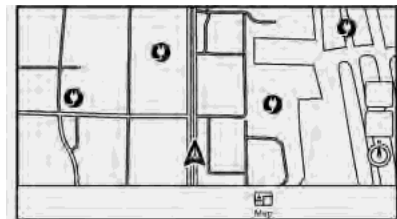

Icons for charging stations can be displayed on the map.

 "Displaying charging station icons on map" (page 2-5)

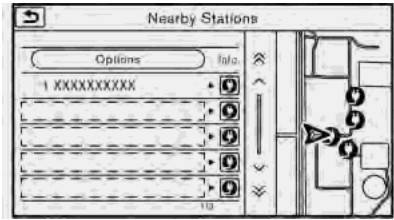

You can also search for charging stations near the current location, set a charging station as a destination or waypoint, and check detailed information about charging stations.

"Finding charging station" (page 3-19)



This vehicle is equipped with a TCU (Telematics Control Unit), a communication device that enables communication with the Nissan Data Center for various telematics services.

"Telematics service" (page IT-3)

When connecting to the Nissan Data

Center, the system will perform an automatic charging station information update near your home once a month. The system will also automatically update information for charging stations near the current vehicle location when the Li-ion battery charge is low. You can also manually update the charging stations around your current vehicle location at any time.

"Updating charging station information" (page 2-7)

Energy usage information display

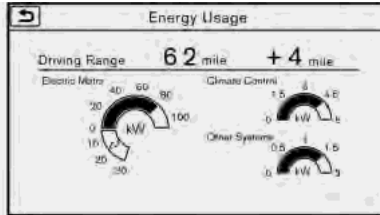

Estimated driving range and energy usage of various systems are displayed. Also, variation of the estimated driving distances between the climate control ON and OFF is displayed.

"Viewing energy usage information" (page 2-8)

TELEMATICS SERVICE

The TCU (Telematics Control Unit) equipped in this vehicle enables the vehicle to use various services (NissanConnect® EV and Services) by connecting the vehicle to Nissan Data Center.

NOTE:

- **Completing the NissanConnect® EV and Services registration at a NISSAN certified LEAF dealer at the time of vehicle purchase is necessary to use this service.**
- **To check the Li-ion battery charging status or to use the remote heater and air conditioner using an internet enabled smart phone or personal computer, the following conditions must be met:**
 - The vehicle must be located in a cellular phone or smart phone coverage area.
 - The internet enabled cellular phone or smart phone must be located in a cellular phone or smart phone coverage area.
 - The computer must be connected to the internet.

IT. System overview

- A cellular phone capable of text messaging must be used to receive text message regarding vehicle charge status.
- When the remote heater and air conditioner is set, the system operates the heater and air conditioner to adjust the in-cabin temperature to a set temperature.
- When the charge connector is disconnected from the vehicle, the heater and air conditioner operates using vehicle Li-ion battery electric power.
- If the remote heater and air conditioner function and Li-ion battery charging are performed at the same time, Li-ion battery charging will take longer than usual due to the power used to heat or cool the vehicle.
- Certain remote functions require a compatible smart phone, which is not included with vehicle.
- NissanConnect® EV and Services information system features are included through a subscription service which requires owner consent to activate. The subscription must be active to use these features.

- NissanConnect® EV and Services communications may be received at a verified e-mail address or by SMS/text messaging-enabled cellular phone.
- Standard text rates and/or data usage may apply depending on your carrier.

Available services

- **Remote Battery Status Check:**
The status of the battery can be checked using your personal computer or cellular phone even if you are not in the vehicle.
- **Unplugged Status, Charge Complete Notification:**
By registering frequently used charging stations, notifications can be sent to your personal computer or cellular phone e-mail address to inform you when the charging connector is disconnected at those locations or charging is completed.
- **Remote Start Charge, Remote Climate Control:**
Remote activation of battery charging or climate control can be set using your personal computer or cellular phone.

- **Li-ion battery warmer status (if so equipped):**

When the ambient temperature is low, the Li-ion battery warmer operates automatically.

Notifications will be sent to your personal computer or cellular phone e-mail address under the following conditions in order to remind you to connect the charging connector.

- Approximately 5 minutes after the Li-ion battery warmer starts operating while the power switch is in the OFF state and the charging cable is not connected to the vehicle.
- Approximately 5 minutes after the Li-ion battery warmer stops operating due to low remaining Li-ion battery power while the power switch is in the OFF state and the charging cable is not connected to the vehicle.



NOTE:

- **The remaining Li-ion battery power lowers gradually while the battery warmer is operating without connecting the charging connector.**

- **When the remaining Li-ion battery power lowers, the battery warmer stops operating. When this occurs, the Li-ion battery temperature lowers gradually, and as a result the EV system may be disabled.**
- **Automatic update of charging stations:**

The information for the charging stations that is recorded in the map data is automatically updated.
- **My Car Finder:**

Location of your vehicle can be checked on your personal computer or cellular phone.
- **Charging Station Map Update:**

Charging station information on the map can be updated on your personal computer or cellular phone.
- **Driving History:**

Driving history can be checked on your personal computer or cellular phone.
- **Charging Station Availability:**

Charging station facility location and information can be checked on your personal computer or cellular phone.
- **Check Cabin Temperature:**

The temperature inside your vehicle can be checked on your personal computer or cellular phone.
- **Set Cabin Temperature:**

The temperature setting of the remote climate control can be changed on your personal computer or cellular phone.
- **Emergency Calling (E-Call):**

The Emergency Calling (E-Call) feature provides emergency assistance by connecting to a Response Specialist. In the event of an emergency, by push the in-vehicle <SOS> button to use this feature. The Response Specialist provides various assistance depending on the situation.

 "Emergency support" (page 5-15)
- **Automatic Collision Notification (ACN):**

The TCU (Telematics Control Unit) generates a signal automatically to the NissanConnect® EV and Services Response Center in the case of an accident severe enough to trigger one of the vehicle's air bags. Upon the signal, a Response Specialist receives the vehicle location and customer information and notifies the proper authorities in accordance with established policies and procedures.
- **Curfew Alert:**

Customers can set time interval for acceptable and unacceptable operation of the vehicle via NissanConnect® Website and Companion App. If the time restrictions are violated, the customer will be automatically notified (e-mail, text message or phone call).
- **Remote Door Lock/Unlock:**

The Remote Door Lock/Unlock feature allows the customer to access the vehicle remotely from the NissanConnect® Website or Companion App to send lock or unlock commands to the vehicle.
- **Remote Sound Horn and Flash Lights:**

Customers can activate the vehicle's headlights and horn via the NissanConnect® Website or Companion App.
- **Alarm Notification:**

Customers will be notified if the vehicle alarm system is activated based on their notification preferences (e-mail, text message or phone call).
- **Boundary Alert:**

Customers can set an area for the vehicle to stay in or out of via the NissanConnect® Website or Companion App. Customers will be notified

IT. System overview

when vehicle is out-of-bounds based on their notification preferences (e-mail, text message or phone call).

- **Maintenance Alert/Reminder:**

The center sends maintenance and other relevant info. to registered e-mail address (PC/Mobile) based on the vehicle information (e.g. driving mileage and etc.) sent at the center access timing. Details of vehicle information are separately examined.

- **Send to Car:**

Customers can access turn-by-turn navigation provided by Google maps and sent directly to the NissanConnect® vehicle.

- **Journey Planner:**

Customers can create a multiple way-point route via Journey Planner on the NissanConnect® Website and send the details directly to their vehicle.

- **Connected Search:**

Customers can access Internet search engines directly from the vehicle to find exact destinations to navigate to.

- **Stolen Vehicle Locator:**

In the event that the customer's vehicle is stolen, after filing a police report the customer can contact NissanCon-

nect® EV and Services Response Center via phone and report the vehicle stolen. At that point, NissanConnect® EV and Services emergency support staff will work with authorities to attempt to recover the vehicle.

- **Valet Alert:**

Customers will be notified if their vehicle is driven more than 0.2 miles (0.4 km) once they activate Valet Alert via the NissanConnect® Website or Companion App.

- **Roadside Assistance Service:**

Enhanced Roadside Assistance allows you to receive assistance from the Roadside Response Specialist for a non-emergency incident that requires a towing or third-party response service. The service is accessed by touching the Voice Menu button on the navigation screen. Roadside Assistance may also be used in conjunction with the Emergency Assistance service, if warranted.

 "Emergency support" (page 5-15)

- **Speed Alert:**

Max Speed Alert allows you to monitor the speed of your vehicle by receiving alerts. You can set the maximum speed via the NissanConnect® Website, and if your vehicle exceeds the

specified speed threshold, you will receive a notification via the chosen method. You can also query the NissanConnect® Website to view a listing of Max Speed Alert notifications.



NOTE:

- **Completing the NissanConnect® EV and Services registration is necessary before using this service.**
- **To check the Li-ion battery charging status or to use the remote heater and air conditioner using an internet enabled smart phone or personal computer, the following conditions must be met:**
 - **The vehicle must be located in a cellular phone or smart phone coverage area.**
 - **The internet enabled cellular phone or smart phone must be located in a cellular phone or smart phone coverage area.**
 - **The computer must be connected to the internet.**
 - **A cellular phone capable of text messaging must be used to receive text message regarding vehicle charge status.**

- **When the charge connector is disconnected from the vehicle, the heater and air conditioner operates using vehicle Li-ion battery electric power.**
- **If the remote heater and air conditioner function and Li-ion battery charging are performed at the same time, Li-ion battery charging will take longer than usual due to the power used to heat or cool the vehicle.**
- **Certain remote functions require a compatible smart phone, which is not included with vehicle.**
- **NissanConnect® EV and Services information system features are included through a subscription service which requires owner consent to activate. The subscription must be active to use these features.**
- **NissanConnect® EV and Services communications may be received at a verified e-mail address or by SMS/text messaging-enabled cellular phone.**
- **Standard text rates and/or data usage may apply depending on your carrier.**

Navigation Telematics (NissanConnect® EV and Services)

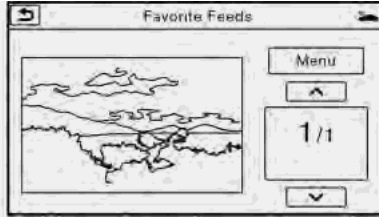

When the system connects to the Nissan Data Center, charging station information will be automatically updated and you can receive useful information for driving your vehicle.

Automatic update of charging stations:

The information for the charging stations that is recorded in the map data is automatically updated.

All Information Feeds:

Convenient information for driving such as weather and traffic information, ECO information shared with the LEAF users, etc. is provided.

Favorites:

When the information of an Internet site is selected and it is stored in the page that is specially established in the NissanConnect® Website, the information is converted into an appropriate format via the Nissan Data Center and provided for use in the vehicle. The content of the information is automatically read out. For the registration method of information data, visit the NissanConnect® Website.

IT. System overview

MEMO

1 Getting started

Control buttons and touch screen display	1-2	Adjusting settings	1-11
Control panel	1-2	How to input letters and numbers	1-11
Steering wheel switches	1-4	How to view and operate HOME	
USB (Universal Serial Bus) Connection Port and AUX (auxiliary) input jack	1-5	MENU screen	1-12
Starting system	1-6	Functions disabled while driving	1-14
Start-up screen	1-6	System settings	1-15
Basic operation	1-7	Setting menu	1-15
Selecting menu from Launch Bar	1-7	Display settings	1-16
Displaying Zero Emission menu screen	1-8	Volume and Beeps settings	1-17
Displaying climate control & audio screen	1-9	Language and unit settings	1-17
Touch panel operation	1-9	Clock settings	1-17
Main screen operations	1-10	Connecting Bluetooth® device	1-18

1. Getting started

CONTROL BUTTONS AND TOUCH SCREEN DISPLAY

CONTROL PANEL



- ① **<☀/🌙>:**
Push to switch between the day (auto) screen (bright) and the night screen (dark). Push and hold to turn off the display. Push again to turn on the display.
☞ "Display settings" (page 1-16)
- ② **<MENU>:**
Push to display the HOME MENU screen.
☞ "How to view and operate HOME MENU screen" (page 1-12)
- ③ **<MAP>:**
Push to display the current location map screen. Push and hold to repeat voice guidance. During route guidance with a map screen displayed, push this button to show/hide the split screen.
☞ "Map operation" (page 3-3)
- ④ **<AUDIO>:**
Push to display the audio screen. Push again to display the audio source menu screen.
☞ "4. Audio system"
- ⑤ **<VOL/ ⏻ >:**
Push to turn the audio system on or off. Turn to adjust the volume.

⑥ SD card slot:

Remove the cover to access the SD card slot. Insert an SD card. Push the inserted SD card in and release it to eject the SD card from the slot. An SD card containing map data is provided with the vehicle and is inserted in the slot.

 "Map data" (page 9-9)

⑦ <CAMERA>:

Models with Intelligent Around View Monitor:

Push to switch to the Intelligent Around View Monitor screen.

See LEAF Owner's Manual for details.

Models with RearView Monitor:

Push to switch to the RearView Monitor setting screen.

See LEAF Owner's Manual for details.

⑧ <⏮>/<⏭>:

In audio operation, selecting and fast-forwarding/rewinding tracks as well as radio station/channel scanning can be performed.

 "Audio main buttons" (page 4-8)

⑨ <⏪> BACK>:

Push to return to the previous screen.

Ⓜ <TUNE-SCROLL/SOUND>:

When a menu screen is displayed, turn the dial to select items on the screen. Push to confirm the selected item or setting.

The button can also be used for audio operations.

 "Audio main buttons" (page 4-8)

Ⓜ Touch screen display:

Various information and operation menus are displayed on the liquid crystal display. Touch keys and icons on the screen for operation.

 "Touch panel operation" (page 1-9)

⚠ NOTE:

Do not remove the SD card containing map data that is inserted in the slot. When this SD card containing map data is removed, the navigation system will not operate. If the SD card containing map data is accidentally removed, after reinserting the SD card containing map data into the slot, place the power switch in the OFF position and then place back in the ON position again.



INFO:

- Never insert foreign objects such as coins into the SD card slot. Doing so may result in a malfunction of the device.
- Do not apply overload to the SD card when inserting it to the slot. Doing so may result in a malfunction of the device.
- The SD card may be hot when it is removed from the device. This does not indicate a malfunction.

1. Getting started

STEERING WHEEL SWITCHES

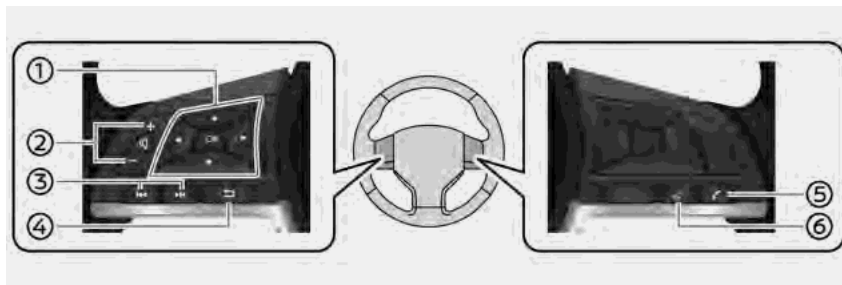

Type A

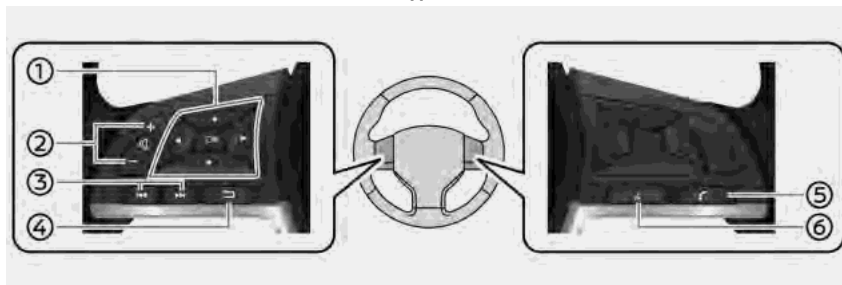

Type B

- ① **< ▲ >/< ▼ >/< ◀ >/< ▶ >/<OK>**:
During voice recognition operation, push < ▲ >/< ▼ > to highlight different items, and push <OK> to select the highlighted item.
< ◀ >/< ▶ > are used mainly for the vehicle information display operation. Refer to the LEAF Owner's Manual for details.
- ② **< + >/< - >**:
Push < + > or < - > to adjust the volume.
- ③ **< ⏪ >/< ⏩ >**:
The buttons can be used for audio operations.
🔗 "4. Audio system"
- ④ **< ⏮ >/< ⏭ >**:
When operating the voice recognition system, push to return to the previous screen. Push and hold to cancel the voice command.
🔗 "8. Voice recognition"
- ⑤ **< 📞 >**:
Push to display the hands-free phone operation screen.
When you receive a phone call, push this button to answer the call.
🔗 "7. Hands-Free Phone"

⑥ < > (TALK):

Push to use the voice recognition system. Push and hold to end the voice recognition session.

 "Giving voice commands" (page 8-2)

When Apple CarPlay™ (if so equipped) is active, pushing and holding this button will start a Siri® voice control session.

 "Siri® operation" (page 6-10)

When Android Auto™ is active, pushing and holding this button will start an Android Auto™ voice control session.

 "Operating with voice" (page 6-13)

USB (Universal Serial Bus) CONNECTION PORT AND AUX (auxiliary) INPUT JACK



WARNING

Do not connect, disconnect or operate the USB device while driving. Doing so can be a distraction. If distracted you could lose control of your vehicle and cause an accident or serious injury.



CAUTION

- **Do not force the USB device into the USB connection port. Inserting the USB device tilted or up-side-down into the port may damage the port. Make sure that the USB device is connected correctly into the USB connection port.**
- **Do not leave the USB cable in a place where it can be pulled unintentionally. Pulling the cable may damage the port.**

The vehicle is equipped with a USB connection port and an AUX input jack. When connected, the in-vehicle audio system can play audio contents from the compatible device.

The USB connection port and the AUX input jack are located on the lower part of the instrument panel.



Example

① Auxiliary input jack:

Connect an audio player that accepts a 1/8 in (3.5 mm) TRS connector (such as an MP3 player etc.) to play back music.

② USB connection port:

Connect to play an iPod®, an iPhone® or a USB memory.



INFO:

- Refer to your AUX and USB device manufacturer's owner information regarding the proper use and care of the device.
- Cables made by Apple Inc. should be used to connect electronic devices

1. Getting started

marketed by Apple Inc.

STARTING SYSTEM

START-UP SCREEN



1. The system starts when the power switch is pushed to the ACC or ON position. The start-up screen is displayed.
2. Check the message that is displayed on the screen and touch [OK].

Subject to the selected items, a different indication may be displayed at subsequent times. The set-up screen will be displayed again after a given period of time.

INFO:

- The data transmission settings can be changed from [Vehicle Data Transmission Setting] in NissanConnect® EV and Services setting.
➤ "NissanConnect® EV and Services settings" (page 5-17)
- If you do not select [OK], vehicle data will not be stored in the Nissan Data Center and you will not be able to check it via the NissanConnect® Website.

Also, if [Share Vehicle Information] is set to OFF, vehicle data will not be uploaded. Make sure that this setting is ON.

When [Service Reminders] is set to ON, communication with the Nissan Data Center will be performed once daily. NISSAN recommends that you set [Service Reminders] to ON.

➤ "NissanConnect® EV and Services settings" (page 5-17)

NOTE:

- **Some of the functions cannot be operated if [OK] is not touched. In that case, the message screen will be displayed again when NissanConnect® EV and Services related menus**

are selected.

- If other buttons such as <MAP> or <MENU> etc., are pushed without touching [OK] or [Decline] being touched, the corresponding screen will be displayed and operations can be performed. However, if the NisanConnect® EV and Services function is selected, the start-up screen will be displayed again.

BASIC OPERATION

The system can be operated with the touch panel as well as switches on the control panel and steering wheel.

This manual mainly describes the touch panel operation.

SELECTING MENU FROM LAUNCH BAR

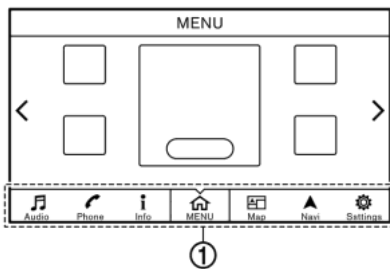

Various system functions can be accessed by touching the items on the Launch Bar ① which is displayed on most of the main menu screens. (The Launch Bar does not appear on some screens such as scrolled map screen, keyboard screen, etc.)

Touch the keys on the Launch Bar to display the corresponding menu screens.

The following menus are available on the

Launch Bar.

- [Audio]
- [Phone]
- [Info]
- [MENU]
- [Map]
- [Navi]
- [Settings]

Audio

Touching [Audio] on the Launch Bar will display the audio screen. When [Audio] is touched while the audio screen is displayed, the audio source menu screen will be displayed.

🔗 "Selecting audio source" (page 4-9)

Phone

Touching [Phone] on the Launch Bar will display the phone menu screen.

INFO:

Pushing < 📞 > on the steering wheel will also display the phone menu screen.

🔗 "7. Hands-Free Phone"

1. Getting started

Info

Touching [Info] on the Launch Bar will display the information menu screen.

Various information can be accessed and viewed from the information menu screen.

☞ "Information menu" (page 6-2)

MENU

Touching [MENU] on the Launch Bar will display the center page of the HOME MENU screen.

The HOME MENU screen consists of three pages which can be personalized by displaying preferred Shortcuts/Widgets.

☞ "How to view and operate HOME MENU screen" (page 1-12)



INFO:

Pushing <MENU> will also display the HOME MENU screen.

Map

Touching [Map] on the Launch Bar will display the map of the current vehicle location.



INFO:

Pushing <MAP> will also display the map screen.

☞ "Displaying current vehicle location" (page 3-3)

Navi

Touching [Navi] on the Launch Bar will display the destination setting screen or the route menu screen, depending on whether a route is set for route guidance.

When a route is not set, menus used to set destination for route guidance can be accessed from this screen.

☞ "Setting destination" (page 3-16)

When a route is set, menus for route information and route editing are displayed on this screen.

☞ "Route menu" (page 3-37)

Settings

Touching [Settings] on the Launch Bar will display the setting menu screen.

Settings for the various functions in the system can be changed from this screen.

☞ "Setting menu" (page 1-15)

DISPLAYING ZERO EMISSION MENU SCREEN

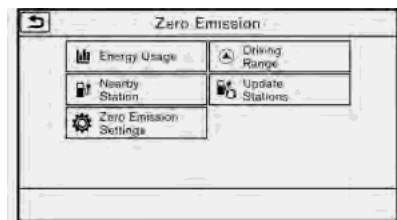

Touch [Info] on the Launch Bar and touch [Zero Emission] to display the menu screen where several useful functions for electric vehicle driving can be set. Select a preferred menu and touch an item to be set.

☞ "Zero Emission menu screen" (page 2-2)

DISPLAYING CLIMATE CONTROL & AUDIO SCREEN

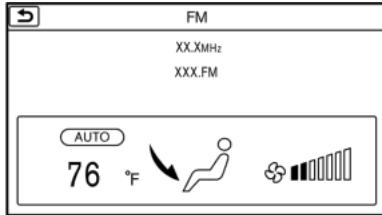

1. Touch [Info] on the Launch Bar.
2. Touch [Climate Control & Audio] to display the climate control information and audio information.

TOUCH PANEL OPERATION

The system can be controlled mainly by the touch panel operation.

• Touch

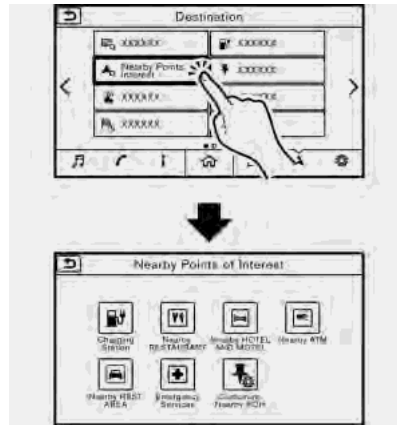

Select a key on the screen to select the item and to display the corresponding screen.

INFO:

Some keys function differently depending on whether the key is touched briefly or when it is being touched and held for a few seconds.

• Swipe/Flick

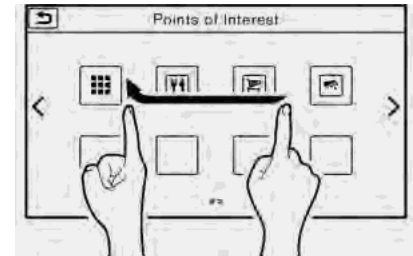

Menu screen pages will skip to the next page when swiped/flicked horizontally.

Some of the list screens can also be scrolled by swiping/flicking on the screen vertically.

1. Getting started

MAIN SCREEN OPERATIONS

• Displaying previous screen

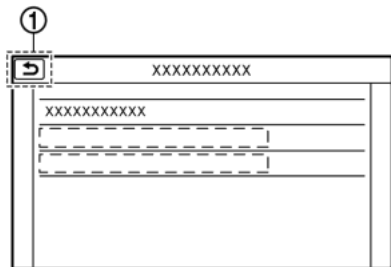

- ① Touch [↩] to return to the screen displayed previously.

• Horizontal scrolling

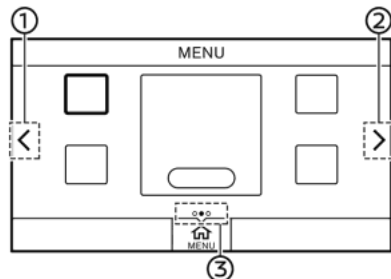

- ① Touch [◀] to scroll to the previous page.
② Touch [▶] to scroll to the next page.
③ Indicates the position of the currently displayed page.

• Vertical scrolling

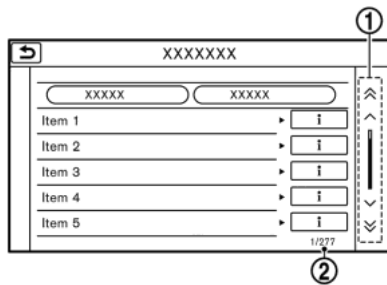

- ① Touch [^] or [v] to scroll the message or list one item at a time.
Touch [⤴] or [⤵] to skip to the next page.
② Indicates the total number of items in the list and the entry number of the selected item.

• Scrolling list by selecting alphabet

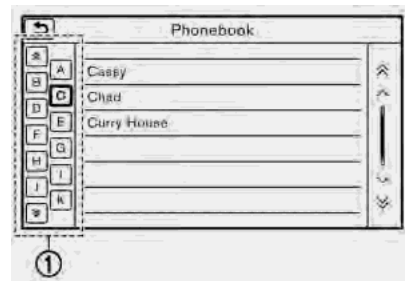

- ① Touch one of the alphabetical keys to scroll the list to the section of the list that begins with the letter selected.

INFO:

Depending on the screens, swiping on the touch screen can scroll pages vertically or horizontally.

ADJUSTING SETTINGS

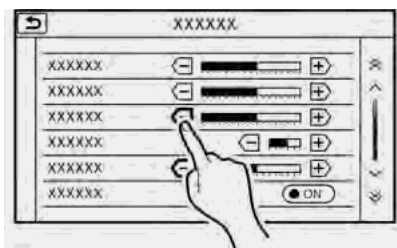

Touch adjustment keys, such as [-]/[+], etc., to adjust each item. Each time a key is touched, the indicator moves along the bar.

For items with [ON] indicator, touch the menu item to turn on/off the setting. The indicator light will turn on when the setting is turned on.

HOW TO INPUT LETTERS AND NUMBERS

Basic operations to enter letters and numbers are explained here.

Character and number input screens vary depending on the conditions.

Alphabet input screen

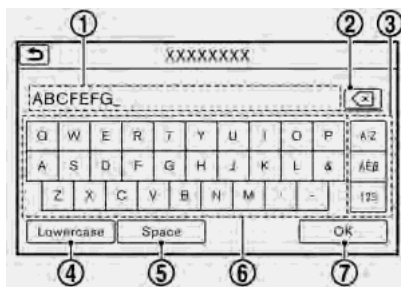

- ① Entered characters are displayed.
- ② Touch to delete the last character entered.
Touch and hold to delete all the characters entered.
- ③ Touch to change the type of keyboard.
[A-Z]: Displays alphabet input screen.
[ÀËß]: Displays symbol input screen.
[123]: Displays number input screen.
- ④ Touch to switch between the uppercase and lowercase character input screen.
- ⑤ Touch to enter a space.

- ⑥ Touch to enter a character.
- ⑦ Touch to confirm the entry.

Number input screen

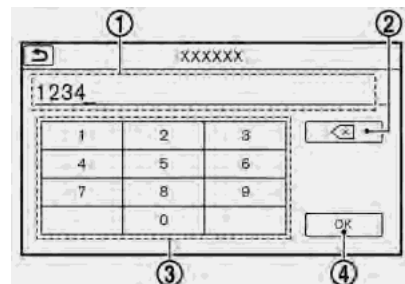

- ① Entered characters are displayed.
- ② Touch to delete the last number entered.
Touch and hold to delete all the characters entered.
- ③ Touch to enter a number.
- ④ Touch to confirm the entry.

1. Getting started

HOW TO VIEW AND OPERATE HOME MENU SCREEN

Push **<MENU>** or touch [MENU] on the Launch Bar to display the HOME MENU screen.

On the HOME MENU screen which consists of 3 pages, preferred Shortcuts and Widgets can be laid out.

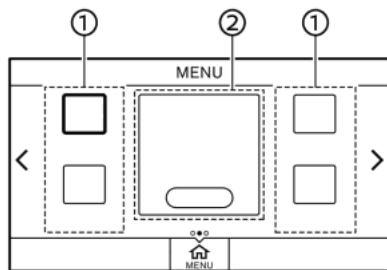

① Shortcut icons

Icons for frequently used menu items can be placed on the HOME MENU screens as Shortcuts. Shortcuts of navigation, information, phone, audio and setting menus are available.

② Widget

Useful information such as audio, weather, clock, etc. can be displayed as Widgets. Depending on the con-

tents, keys in the box can be touched for operations.



INFO:

The HOME MENU screen can be edited.
☞ "Customizing HOME MENU screen" (page 1-13)

Default menus:

The following Shortcuts and Widgets are set to be displayed as default on the HOME MENU screen.

Shortcuts/Widgets	Content
[Smartphone Connection]	Displayed when neither iPhone® nor Android phone is connected.
[Apple CarPlay]*1 (if so equipped)	Page 6-9
[Android Auto]*2	Page 6-12
[Charging Station]	Page 3-19
[Climate Control & Audio]	Page 1-9
[Energy Usage]	Page 2-8
[SXM Traffic]	Page 6-2
[SXM Weather]	Page 6-2
[SXM Movie Listings]	Page 6-2
[SXM Sports]	Page 6-2
[SXM Stocks]	Page 6-2
[Call History]	Page 7-4
[Home]	Page 3-23
[Edit Menu]	Page 1-13
[Previous Destinations]	Page 3-24
[Audio Information]	Audio Information is displayed.
[Digital Clock]	Digital clock is displayed.

- *1: Displayed when iPhone® is connected.
- *2: Displayed when Android phone is connected.

INFO:

- Default menus on the HOME MENU screen are subject to change without notice.
- A SiriusXM Travel Link or SiriusXM Traffic subscription is necessary to receive SXM information services.

Customizing HOME MENU screen

The HOME MENU screen can be personalized by selecting which Shortcuts and Widgets to be displayed and where to place them on the screen.

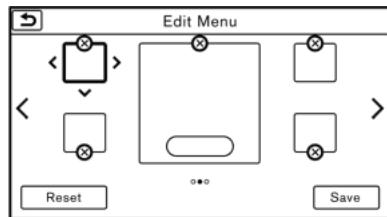

1. Push and hold <MENU> or touch and hold [MENU] while the HOME MENU screen is displayed.

2. Edit the Shortcuts and the Widgets on the Edit Home Menu screen.
 3. Touch [Save] to apply the change.
- Following editing operations are available.

Moving an item:

1. Touch a Widget or a Shortcut icon you wish to move. The arrows [<], [>], [^] or [v] will appear by the icon. (Only [<] and [>] are available for the Widget.)
2. Touch the arrows to move the icon.

Adding an item:

1. Touch a blank box for Widget/Shortcut.
2. Touch [+] displayed by the box.
3. Touch [Shortcut Icons] or [Widgets] and select a preferred item you wish to add.

• Available Shortcut categories

- [Audio Source]
- [Phone]
- [Info]
- [Navigation]
- [Settings]

• Available Widgets

- [Audio Information]
- [Current Conditions]
- [5-Day Weather Forecast]
- [Digital Clock]
- [Analog Clock]

INFO:

To add a Widget, 4 open Shortcut spots are needed.

Deleting an item:

Touch [X] on the Shortcut or Widget you wish to delete. Touch [Delete] to confirm.

Setting layout to default:

Touch [Reset] on the Edit Home Menu screen. Touch [Yes] to confirm.

INFO:

- Touching [Settings] on the Launch Bar and touching [Edit Home Menu] will also display the Edit Home Menu screen.
- Access to the SiriusXM Travel Link services requires a SiriusXM subscription.
 "SiriusXM Travel Link" (page 6-7)

1. Getting started

- Available Shortcuts/Widgets and the default menus on the HOME MENU screen are subject to change without notice.

FUNCTIONS DISABLED WHILE DRIVING

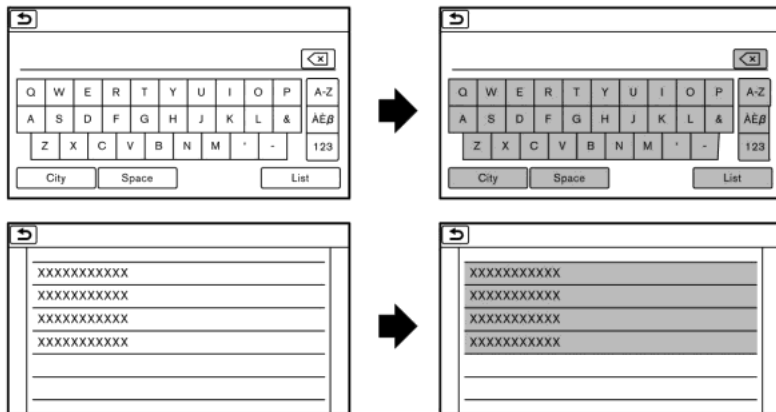

Example

To ensure safe driving, some functions cannot be operated or have limited operation while the vehicle driving speed is 5 MPH (8 km/h) or above.

The on-screen text and keys for these restricted functions will be "grayed-out" or muted and cannot be selected while driving. In some cases, a screen message will appear indicating a restricted function.

Restricted functions while driving include:

- Character (letter and number) input screen.
- Scrolling and viewing of certain list screens
- Displaying detail information and touching item on some information screen
- Adding/editing home location, address book entries and current route
- Registering cellular phones
- Connecting Bluetooth® devices for the first time
- Making a call by dial number and handset phonebook
- Setting phone, NissanConnect® EV and Services, Bluetooth® functions, etc.

- Various other settings

These functions will become available again when the vehicle speed is reduced to below 5 MPH (8 km/h).

Some of the destination setting functions that become unavailable while driving can be operated by voice recognition system. Available voice commands may differ depending on the language setting.

SYSTEM SETTINGS







The system settings can be changed for convenience.





SETTING MENU



Touch [Settings] on the Launch Bar and touch a setting item you wish to adjust.

1. Getting started

Available setting items

Setting item	Result
[Bluetooth]	Displays the Bluetooth® Audio and Phone setting screen.  "Bluetooth® settings" (page 1-18)
[Phone]	Displays the Phone & Mail setting screen.  "Phone and text message assistant settings" (page 7-10)
[Navigation]	Displays the navigation settings screen.  "Navigation settings" (page 3-60)
[Sound]	Displays the audio settings screen.  "Audio settings" (page 4-26)
[Display]	Displays the display settings screen.  "Display settings" (page 1-16)
[Volume & Beeps]	Displays the volume adjustment screen.  "Volume and Beeps settings" (page 1-17)

[Clock]	Displays the clock adjustment screen.  "Clock settings" (page 1-17)
[Edit Home Menu]	Displays the menu editing screen.  "Customizing HOME MENU screen" (page 1-13)
[NissanConnect EV & Services]	Displays the NissanConnect® EV and Services settings screen.  "NissanConnect® EV and Services settings" (page 5-17)
[Voice Recognition]	Displays the voice recognition system settings screen.  "Voice recognition settings" (page 8-19)
[Camera] (if so equipped)	Displays the Camera setting screen. See LEAF Owner's Manual for details of the monitor system.

[Language & Units]	Displays the Language and Units settings screen.  "Language and unit settings" (page 1-17)
[Apple CarPlay Settings] (if so equipped)	Displays the Apple CarPlay™ setting screen.  "Apple CarPlay™ settings" (page 6-11)
[Android Auto Settings]	Displays the Android Auto™ setting screen.  "Android Auto™ settings" (page 6-14)

DISPLAY SETTINGS

Menu items to adjust display settings are available.

1. Touch [Settings] on the Launch Bar.
2. Touch [Display].
3. Touch a preferred adjustment item and adjust to the preferred setting.

Available setting items

Setting item	Action
[Display]	Turns the screen off. Pushing and holding <⌘/> will also turn off the screen. Push <⌘/> to turn the screen back on.
[Brightness]	Adjusts the brightness of the display.
[Contrast]	Adjusts the contrast of the display.
[Background Color]	Changes the background color of the map screen. Select the color mode from [Day] and [Night]. Pushing <⌘/> will also change the background color.

VOLUME AND BEEPS SETTINGS

The volume of various functions including audio, phone, navigation voice guidance, and system beeps can be adjusted.

1. Touch [Settings] on the Launch Bar.
2. Touch [Volume & Beeps].

Available setting items

Setting item	Action
[Audio Volume]	Adjusts the volume level of the audio system.
[Guidance Volume]	Adjusts the volume level of the guidance voice and the voice recognition system voice responses.
[Ringtone]	Adjusts the volume level of the ringtone of incoming calls.
[Incoming Call/Siri]/[Incoming Call]	Adjusts the volume level of the incoming call or Siri® (if so equipped).
[Outgoing Call]	Adjusts the outgoing call volume.
[NissanConnect EV/Svcs]	Adjusts the volume level of "text-to-speech" for text messaging and NissanConnect® EV and Services announcements.
[Button Beeps]	Turns on/off the button beep sound and alarm for a prohibited operations.
[Guidance Voice]	Turns on/off the voice guidance.

LANGUAGE AND UNIT SETTINGS

This changes the display language and measurement unit used in the system.

1. Touch [Settings] on the Launch Bar.
2. Touch [Language & Units].

Available setting items

Setting item	Action
[Select Language]	Selects the system language. The language setting is applied to the touch screen display, voice announcements, the voice recognition system.
[Select Units]	Selects the system unit. The unit setting can also be applied to the information vehicle display.



INFO:

Do not push the power switch while changing the language.

CLOCK SETTINGS

Clock settings of the system can be changed.

1. Touch [Settings] on the Launch Bar.
2. Touch [Clock].

1. Getting started

Available setting items

Setting item	Action
[On-screen Clock]	Sets the clock display on/off. When this item is on, the clock display appears.
[Clock Format (24h)]	Turns on/off the 24-hour display mode. When turned off, the clock is set to the 12-hour mode.
[Offset (hour)]	Adjusts the offset value (hour).
[Offset (min)]	Adjusts the offset value (minutes).
[Daylight Savings Time]	Turns on/off the daylight saving time setting.
[Time Zone]	Select an appropriate time zone from the list. When selecting [Auto], the system selects the time zone automatically.

CONNECTING BLUETOOTH® DEVICE

Your vehicle is equipped with the Bluetooth® Hands-Free Phone System and Bluetooth® audio player. If you are an owner of a compatible Bluetooth® enabled cellular phone or Bluetooth® audio device, you can set up the wireless connection between your cellular phone and the in-vehicle phone module or Bluetooth® audio and in-vehicle audio module. With Bluetooth® wireless technology, you can make or receive a telephone call with your cellular phone in your pocket and listen to Bluetooth® audio.

Connecting cellular phone/audio device

To use the Bluetooth® device with the in-vehicle system for the first time, the device connection operation is required.

1. Touch [Settings] on the Launch Bar.
2. Touch [Bluetooth] and touch [Connect Device]. A message is displayed.
3. Touch [Yes] to connect a cellular phone. Touch [No] to connect an audio device and operate as guided by the system. (Operations may differ depending on the device.)

NOTE:

Some cellular phones or other devices may cause interference or a buzzing noise to come from the audio system speakers. Storing the device in a different location may reduce or eliminate the noise.

INFO:

- Up to 5 Bluetooth® devices can be connected. If 5 devices are already connected, one of the devices must first be deleted before another device can be connected.
 "Bluetooth® settings" (page 1-18)
- The pairing procedure of the cellular phone varies according to each cellular phone. See the cellular phone Owner's Manual for the details.
- Visit www.nissanusa.com/bluetooth/ for a recommended Bluetooth® device.

Bluetooth® settings

The Bluetooth® settings can be changed according to the your preference.

1. Touch [Settings] on the Launch Bar.
2. Touch [Bluetooth].

3. Touch a preferred item.

Available setting items

Setting item	Action
[Bluetooth]	Turns the Bluetooth® connection to the vehicle on/off.
[Connect Device]	Bluetooth® devices can be connected to the in-vehicle system.
[Select BT Device]	Registered Bluetooth® devices are shown on the list. Select a device you wish to use from the list. You can also edit the name, delete registered devices or display information of the registered device.
[Edit Bluetooth Information]	The in-vehicle system name and the PIN code can be changed. A device address can also be viewed.



INFO:

From [Edit Bluetooth Information], the device name that appears on the screen can be changed and be renamed from the name set as default to the preferred name (such as “Steve’s Car” for example).

1. Getting started

MEMO





2 Unique EV functions

Zero Emission menu screen	2-2	Updating charging station information	2-7
Displaying estimated driving range and charging station information	2-3	Energy usage information display	2-8
Displaying estimated driving range	2-3	Viewing energy usage information	2-8
Displaying charging station icons on map	2-5	Unique EV function settings	2-9
Confirming charging station availability	2-6	Battery information	2-11

2. Unique EV functions

ZERO EMISSION MENU SCREEN

Touch [Info] on the Launch Bar and touch [Zero Emission] to display the menu that includes useful functions for electric vehicle driving.

Setting items	Action
[Energy Usage]	Energy usage information is displayed on the screen.  "Energy usage information display" (page 2-8)
[Driving Range]	The estimated driving area within range, including the current position is displayed on the map screen.  "Displaying estimated driving range" (page 2-3)
[Nearby Station]	Charging station information for the current position area is displayed.  "Finding charging station" (page 3-19)
[Update Stations]	Charging station information is updated through connection to the Nissan Data Center.  "Updating charging station information" (page 2-7)
[Zero Emission Settings]	Various EV-specific settings can be adjusted from this menu.  "Unique EV function settings" (page 2-9)

DISPLAYING ESTIMATED DRIVING RANGE AND CHARGING STATION INFORMATION

The estimated driving range and charging station information are displayed on the map screen.



CAUTION

Charging station information may not be detailed in all areas or reflect current charging station locations. For up to date information about charging stations, such as business hours or charging equipment, NISSAN recommends that you directly access the information on your own. Additionally, always check the Li-ion battery available charge and set a reasonable driving schedule.

DISPLAYING ESTIMATED DRIVING RANGE

The estimated driving range including the current position or the destination is displayed on the map screen depending on the charging status of the vehicle. A destination or a waypoint can be set on this screen.



INFO:

The estimated driving range map shows the predicted area the vehicle can reach on the basis of the estimated driving range that is indicated in the meter. Driving habits, the actual road environment (hills, etc.), and traffic conditions (traffic jams, etc.) will affect the actual available range.

To display the estimated driving range, touch [Driving Range] in the Zero Emission menu.



"Zero Emission menu screen"
(page 2-2)



INFO:

Models with Li-ion battery warmer:
The estimated driving range will increase or decrease when the air conditioner, heater or Li-ion battery warmer is turned on or off, or the vehicle is shifted between

D (Drive) and ECO, or when any other accessory is turned on or off based on driving.

2. Unique EV functions

How to view driving range screen

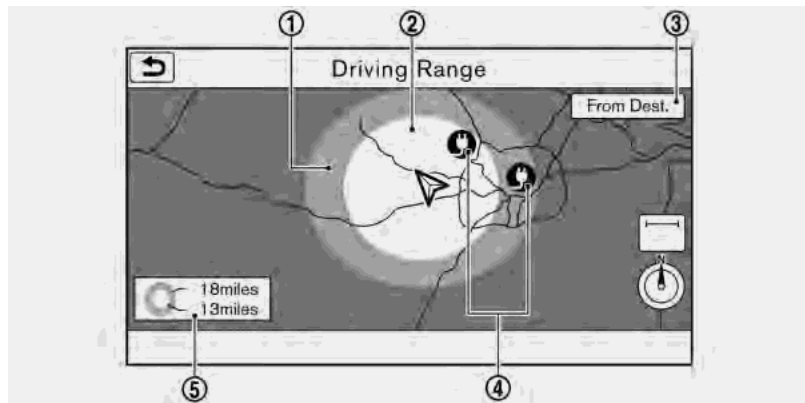

- ① The extended estimated driving range is displayed using the possible driving distance on the meter as a radius.
- ② The normal estimated driving range is displayed based on the current charging condition.
- ③ [From Dest.]:
The estimated driving range around the destination is displayed while setting the route. If some waypoints are set, the nearest waypoint from the

current vehicle position is centered on the estimated driving range map.

[Go Here]:

Any locations that are displayed within the estimated driving range can be set as a destination or a waypoint.

- ④ Charging station icons:

- 🔌: Normal charge icon
- ⚡: Quick charge icon (for vehicle equipped for quick charging)

- ⑤ The possible driving distance is displayed for each estimated driving range.

INFO:

When a route is set that includes waypoints, the estimated driving range will be displayed based on the nearest waypoint.

Setting a charging station as a destination

While the estimated driving area is displayed on the map screen, the spot where the cross pointer is placed by moving the map can be set for the destination.

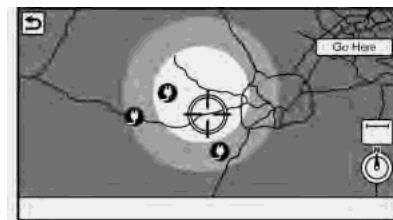

1. Scroll the map, place the cross pointer over the preferred location, and touch

2. Unique EV functions

[Go Here].

- When a message asking if you wish to set the location as a destination, touch [Yes].
- The system sets the destination to the selected location and starts calculating a route.

INFO:

- This procedure only allows you to set a destination or waypoint on the driving range screen. The system does not automatically set a desired charging station as a destination or waypoint. When a charging station displayed on the map is set as a destination by moving the map, zoom in the map and set a point as a destination as precisely as possible. If the destination is not set precisely, the system may provide guidance to a location that is not a charging station.
- The driving range is displayed as a numeric value above the destination or waypoint that has been set. The values displayed here are approximate and should only be used as a guide.
- If setting a destination when the Li-ion battery power level may be insufficient to reach the set destination, the in-

formation for charging stations is displayed, allowing you to set a charging station as the destination.

DISPLAYING CHARGING STATION ICONS ON MAP

The charging station icons are displayed on the map screen. There are two types of icons: quick charge (for vehicle equipped for quick charging) and normal charge.

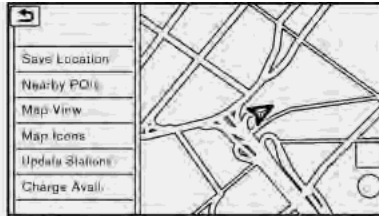

- Touch  while the current location map screen is displayed.

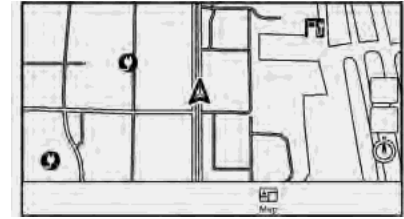

- Touch [Map Icons]. A list of map icon types is displayed.
- Touch [Charging Station]. The indicator illuminates when the item is set.



- Push **<MAP>** to return to the current location map screen. The charging station icons are displayed on the map.

-  : Normal charge icon
 : Quick charge icon (for vehicle equipped for quick charging)



2. Unique EV functions

INFO:

When a charging icon on the map is touched, a pop-up screen will appear.

- Touch [Go Here] to set the location as a destination.
- Touch [Place Info] to display charging station information.

Other settings

The charging station icon can be also set by performing the following procedure.

1. Touch [Zero Emission Settings] in the Zero Emission menu.
 "Zero Emission menu screen" (page 2-2)
2. Touch [Map icons for charging stations].

or

1. Touch [Settings] on the Launch Bar.
2. Touch [Navigation].
3. Touch [Map Icons].

INFO:

- Setting can be changed to display normal charge station icons only or to display both the normal charge and quick charge station icons on the map. To display normal charge station icons only, turn off the setting of [QUICK

CHARGE] in [Charge Port Types to Include in Station Searches] menu.

 "Unique EV function settings" (page 2-9)

- The map icons are not displayed on the map screen when the map scale is set to 1/4 mile (500 m) or higher in the 2D map and the Birdview™ map.
- Settings of the charging station icons registered in the address book cannot be changed with this procedure.
 "Editing stored home and location" (page 3-55)

CONFIRMING CHARGING STATION AVAILABILITY

It is possible to confirm the availability of charging stations via the Nissan Data Center. This allows you to reduce the time spent waiting to charge.





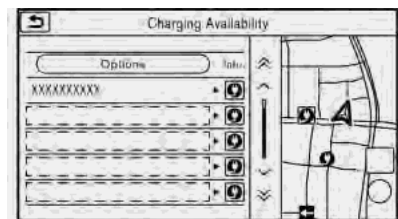

Viewing from information menu screen

1. Touch [Info] on the Launch Bar.
2. Touch [NissanConnect EV & Services].
3. Touch [Charging Availability].
4. Select the area for charging station search.
 - [Near Current Location]:
Displays a list of charging stations that are near the current vehicle location.
 - [Near Destination]:
Displays a list of charging stations that are near the destination, when a destination has been set.
 - [Near Scroll Position]:
Displays a list of charging stations that are near the cursor when the map has been moved.



2. Unique EV functions

5. A list screen is displayed. Confirm the charging station information from the list. Full/vacant information of charging station is indicated by icon color.

Icons	Charging station type	Availability
	Normal charge icon	Green: Fully vacant Yellow: Partly vacant Red: Full
	Quick charge icon	Gray: No information or unclear
	Normal charge icon	Closed or out of service
	Quick charge icon	
	Normal charge icon	No information
	Quick charge icon	



INFO:

Touch [Options] to select types of charging stations you wish to include in the searched location list.

Available items:

- [Show Along Route]: Shows charging stations located along the route to destination.

- [Show Quick Charging Stations Only]: Shows charging stations with quick charger.
- [Available Spot Only]: Shows charging stations that are available.
- [Free Only]: Shows charging stations that are free of charge.
- [Select Payment System]: Select payment method and the usable charging stations are displayed.

Viewing from map menu

Charging station information can also be obtained from map menu.

1. Touch  while the current location map screen is displayed and then touch [Charge Avail.].
2. The system connects to Nissan Data Center, and a list of search results will be displayed.

UPDATING CHARGING STATION INFORMATION

An active NissanConnect® EV and Services subscription is needed to update charging station information.

Information about the charging stations that are located around the current position, destination and your home is updated through connection to the Nissan Data Center.

While the vehicle is connecting to the Nissan Data Center, information related to charging stations in the area around your home will be automatically updated. Also, when the driving range is restricted, information related to charging stations in the area near the current vehicle location will also be automatically updated.

1. Touch  "Unique EV function settings" (page 2-9)

Charging station information for the area around a location set can be updated manually by using the following procedure.

1. Touch [Update Stations] in the Zero Emission menu.
Touch  "Zero Emission menu screen" (page 2-2)

2. Unique EV functions

2. Touch the preferred setting item. The system then connects to the Nissan Data Center and the update of charging station information will start.

Available settings

- [Near Current Location]:
Charging station information for the area around the current position is updated.
 - [Near Destination]:
Charging station information for the area around the destination is updated.
 - [Near Home]:
Charging station information for the area around your home is updated. Registration of your home in the Address Book is necessary before using this item.
 "Storing home location" (page 3-52)
 - [Near a location on the Map]:
Charging station information for the area where the cross pointer is placed by moving the map is updated.
3. When the update is completed, a message is displayed.



INFO:



- When [Stop] is touched while updating information, connection to the Nissan Data Center is disconnected.
- If communication with the Nissan Data Center is disconnected due to poor signal reception, a message will be displayed. Touch [Yes] to restart the download.

ENERGY USAGE INFORMATION DISPLAY

Energy usage information is displayed.

VIEWING ENERGY USAGE INFORMATION

Estimated driving range and energy usage of various systems are displayed.

Touch [Energy Usage] in the Zero Emission menu.

-  "Zero Emission menu screen" (page 2-2)

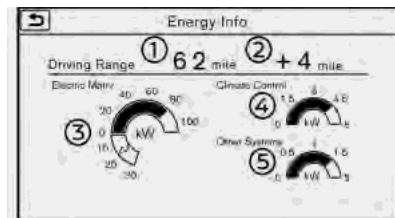

- ① Driving Range:
The possible driving distance based on the current charging status is displayed.
- ② Variable distance:
When the climate control system is turned on, the additional distance the vehicle can drive by turning the cli-

mate control system off is displayed. When the climate control system is turned off, the distance the vehicle can drive less if the climate control system is turned on is displayed.

- ③ Electric Motor:
Energy usage by the motor and regenerated energy are displayed.
- ④ Climate Control:
Energy usage by the climate control function is displayed.
- ⑤ Other Systems:
Energy usage by other equipment (headlights, windshield wiper, etc.) is displayed.





UNIQUE EV FUNCTION SETTINGS

EV unique function settings can be changed.

An active NissanConnect® EV and Services subscription is needed to remotely check charge status, battery status, use remote charging, remotely start heating and cooling and to receive e-mails/text messages.

1. Touch [Zero Emission Settings] in the Zero Emission menu.
 "Zero Emission menu screen"
(page 2-2)
2. Touch the item you wish to set.

2. Unique EV functions

Setting items		Action
[Battery Alerts]	[Use All Battery Alerts]	Displays all battery alerts on the navigation screen.
	[Low Battery]	Displays the Low Battery message on the touch screen display to inform the driver that the Li-ion battery charge is low.  "Low Battery" (page 2-11)
	[Dest. out of Range]	Displays a message on the navigation screen to inform the driver that the battery should be charged soon. This will be indicated if the estimated driving range is less than the remaining distance to the destination when a route to the destination is set.  "Charge recommendation guidance" (page 2-11)
[Charging Messages]	Sends a notification to a preset e-mail address. This notification includes the charge connector status and the charge completion.  "NissanConnect® EV and Services settings" (page 5-17)	
[Map icons for charging stations]	Displays charging station icons on the map screen.  "Displaying charging station icons on map" (page 2-5)	
[Other Settings]	[Autosave New Charging Station]	If charging station information you have used is not stored in the system, the location will be automatically registered in the Address Book. Turn this setting off if you do not want the charging location to be stored automatically. You can set charging stations that are automatically registered by type. Select from [Quick], [Standard] and [Trickle].
	[Auto-Update Stations]	While the vehicle is connecting to the Nissan Data Center, information related to charging stations near your home will be automatically updated.
	[Charge Port Types to Include in Station Searches]	When [QUICK CHARGE] setting is turned off, the quick charge icon will not be displayed.
	[Show Icon of Closed Charging Station]	When this item is turned on, the charging stations that are out of business hours are displayed and shown as icons.

INFO:

- For vehicles without the quick charge port, NISSAN recommends turning off the quick charging station icons by turning off the [QUICK CHARGE] setting.

BATTERY INFORMATION

Information notifying the driver of the battery status can be displayed on the touch screen display.

For detail information about the warning/indicator lights, see the LEAF Owner's Manual.

Charge recommendation guidance

If the remaining driving range is less than the distance to the destination that is entered while setting the route, the system displays a message on the navigation screen that recommends battery charging.

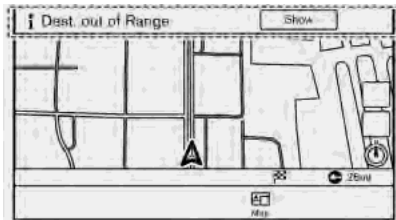

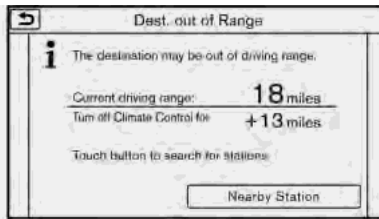

- The notification is displayed on the upper left side of the screen. Touch [Show] to display the detailed information screen.



- The system displays a message screen and announces the contents of the message to recommend battery charging. Check the message displayed on the screen.

Touch [Nearby Station] to search all charging stations that are located near the current vehicle location.



 "Finding charging station" (page 3-19)

- Touch [, touch [Map] on the Launch Bar or push <MAP> to return to the current location map screen.

INFO:

- The charge recommendation guidance can be set to off.
 "Unique EV function settings" (page 2-9)
- When the route is changed to avoid a traffic jam or the possible driving distance indicated in the meter is changed, the charge recommendation guidance is displayed again.

Low Battery

When the Low battery charge warning light  and the master warning light (yellow)  illuminate in the meter, the system displays a message on the touch screen display that notices the driver that the Li-ion battery charge is low.

2. Unique EV functions

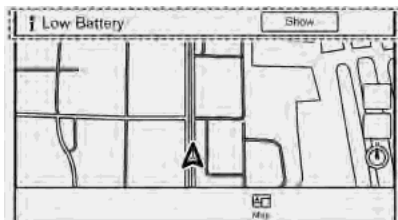

1. The notification is displayed on the upper left side of the screen. Touch [Show] to display the detailed information screen.

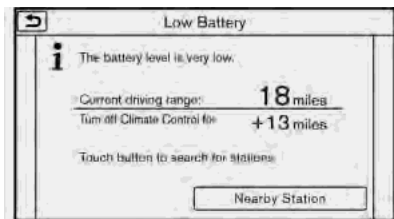

2. The system displays a message screen and announces the contents of the message to warn that the Li-ion battery charge is low. Check the message displayed on the screen.

Touch [Nearby Station] to search all charging stations that are located near the current vehicle position.

"Finding charging station"

(page 3-19)

3. Touch [], touch [Map] on the Launch Bar or push <MAP> to return to the current location map screen.



INFO:

- The Low Battery message display can be turned off.
 "Unique EV function settings"
(page 2-9)
- When the Li-ion battery charge is low, the system automatically obtains charging station information.

3 Navigation

Safety information	3-3	Setting using Google Maps	3-27
Map operation	3-3	Setting destinations by Google	3-27
Displaying current vehicle location	3-3	Setting using Route Planner	3-28
Map types	3-3	Setting point on map	3-28
Road color	3-6	Setting with NissanConnect® EV and Services	3-28
Map symbols	3-7	Searching by using Voice Menu button on map	3-29
Moving map	3-8	Options before starting the route guidance	3-29
Changing scale of map	3-9	Route guidance	3-31
Changing map	3-10	About route guidance	3-31
Map view settings	3-11	Route menu	3-37
Setting information on map	3-14	Setting new destination	3-40
Traffic information on map	3-15	Canceling Route	3-40
Map Menu screen	3-15	Confirming route	3-40
Setting destination	3-16	Editing route	3-40
Basic operations	3-16	Recalculating route	3-43
Finding address	3-19	Searching for detour route using traffic information	3-43
Finding charging station	3-19	Setting detour route	3-44
Finding nearby place	3-21	Route guidance settings	3-44
Finding points of interest	3-21	Viewing traffic information	3-49
Setting home as destination	3-23	Viewing available traffic information	3-49
Searching from address book	3-24	Traffic information setting	3-51
Searching from previous destinations	3-24	Storing a location/route	3-52
Setting intersection	3-25	Storing location	3-52
Setting by phone number	3-25	Storing route	3-53
Setting city center	3-26		
Setting freeway entrance/exit	3-26		
Setting from stored routes	3-26		

Storing avoid area	3-53
Editing stored information	3-54
Deleting stored item	3-57

Transferring information to/from address book	3-58
Navigation settings	3-60

SAFETY INFORMATION

The navigation system is primarily designed to help you reach your destination. However, you, the driver, must use the system safely and properly. Information concerning road conditions, traffic signs and the availability of services may not always be up to date. The system is not a substitute for safe, proper, and legal driving.



WARNING

- **Do not rely on route guidance alone. Always be sure that all driving maneuvers are legal and safe in order to avoid accidents.**

MAP OPERATION

DISPLAYING CURRENT VEHICLE LOCATION

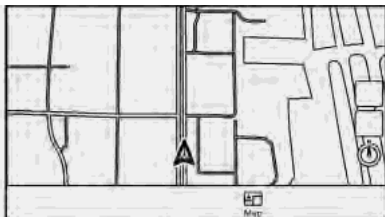

Push **<MAP>** or touch [Map] on the Launch Bar to display the map of current vehicle location.

MAP TYPES

Two types of map views are available: 2D map and Birdview™ (3D) map.

always pointing up.

Touch the icon to change the map view and the map orientation.

 "Changing map view and map orientation" (page 3-10)

- ⑪ Remaining distance to the destination:

Indicates the approximate remaining distance to the destination or waypoint. This indicator will appear when a destination or waypoint is set and route guidance is started.

The arrow displayed here indicates the direction of the destination. It can be displayed only when the map scale is in the range of 1/64 miles (25 m) - 1/8 miles (200 m).

- ⑫ Estimated time to the destination:

Indicates the estimated time to the destination or waypoint. This indicator will appear when a destination or waypoint is set and route guidance is started.

 "Guidance settings" (page 3-45)

- ⑬ Traffic indicator:

Indicates the reception condition of the traffic information transmitted from the provider.

Green: Reception condition is good.

Gray: Reception condition is not good.

The indicator does not appear without a SiriusXM Traffic subscription.

- ⑭  Vehicle icon:

Indicates the current vehicle location and the direction the vehicle is heading.

- ⑮ Suggested route:

Appears in bold blue during route guidance.

- ⑯  Stored location (yellow):

Displays the locations that are stored in the Address Book.

 "Storing location" (page 3-52)

The icons can be changed according to your preferences.

- ⑰ Street name:

Displays the name of the street that the vehicle is currently driving on.

- ⑱ Voice Menu button:

Touch the icon to connect to the NissanConnect® EV and Services Voice Menu.

 "Connecting to Interactive Voice Menu" (page 5-12)

Birdview™ (3D) map

Birdview™ displays the map from an elevated perspective. In Birdview™, it is easy to recognize an image of the route because it provides a panoramic view over a long distance.

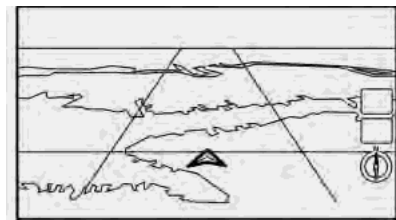

INFO:

Note the following items about the Birdview™ display.

- "Birdview™" is a registered trademark of Clarion Co., Ltd.
- The map in Birdview™ always appears with the current forward direction facing up.

3. Navigation

Building graphics

In an area where the building graphics are stored in the map data, the building graphics are displayed when the map is zoomed in. On the 2D map display, these are called "Building footprint graphics", and on the Birdview™ display, these are called "3D building graphics".

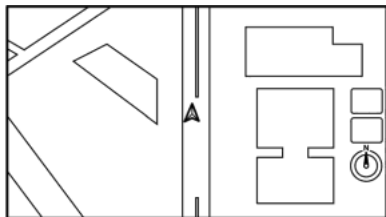

Building footprint graphics (2D map)

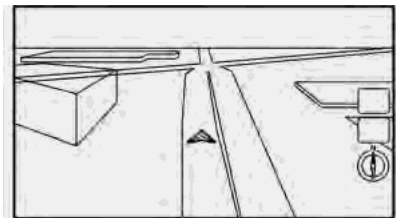

3D building graphics (Birdview™ map)



INFO:

In an area where the building graphics are not stored in the map data, the normal map is displayed even when the map is zoomed in.

ROAD COLOR

The road types are differentiated by color.

Red	Freeway
Brown	Main road
Dark Yellow	
Gray	Narrow street
Dark green	Road with incomplete map data

MAP SYMBOLS

This navigation system uses symbols to display facilities.

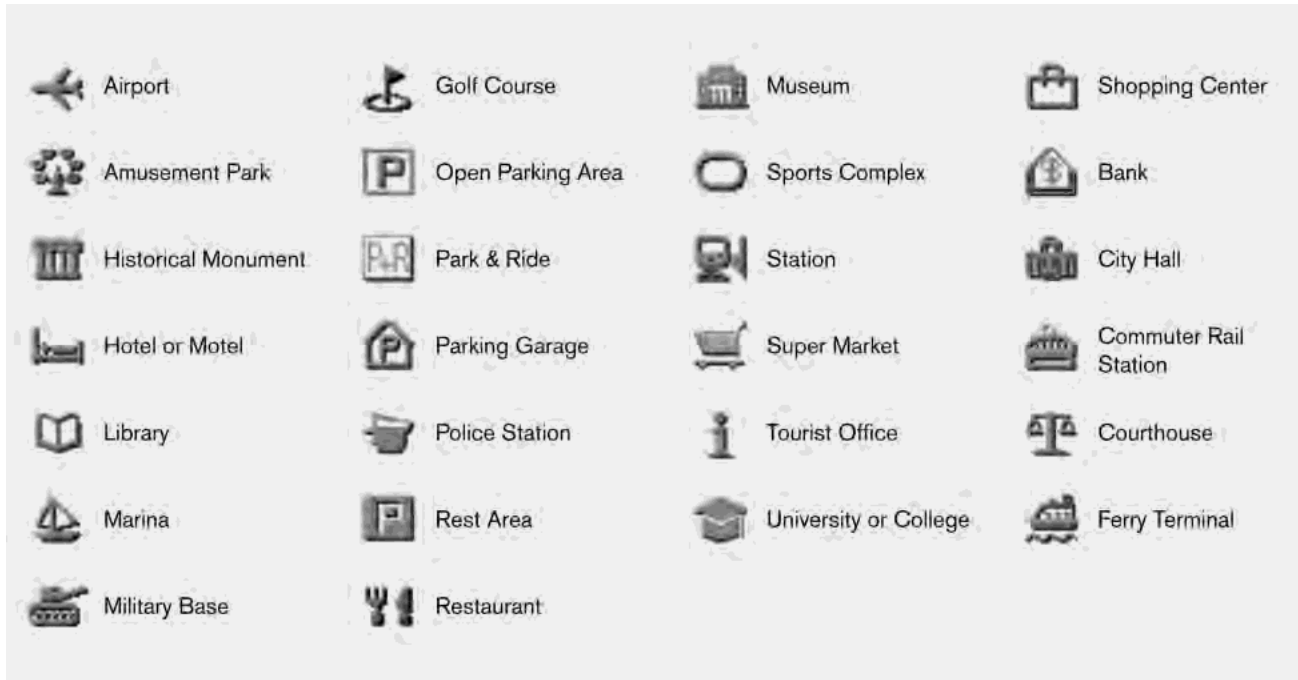

2-dimensional icons (Plan View)



3. Navigation

Charging station icons:

Charging station locations are displayed with icons below on the map.



-  : Normal charge icon
-  : Quick charge icon (for vehicle equipped for quick charging)

INFO:



- The charging station icons are not displayed on the map screen when the map scale is set to 1/4 mile (500 m) or wider.
- Charging station icon display can be turned on/off.
 "Displaying charging station icons on map" (page 2-5)

When the map scale is set between 1/32 miles (50 m) and 1/16 miles (100 m), icons below can be displayed.

- When charging station information is updated, the updated charging stations will be displayed as icons with "New" marked by the charging station icon.

	Updated normal charge station
	Updated quick charge station

- Charging stations that are registered as open 24 hours are displayed in icons with "24" marked by the charging station icon.

	24 hours open normal charge station
	24 hours open quick charge station

INFO:

The "New" and "24" indicators are not available when the map scale is in 1/8 miles (200 m) level or wider.

MOVING MAP

Map can be scrolled by touch screen operations. Map scrolling operations are limited and not fully available while driving.

Touch:

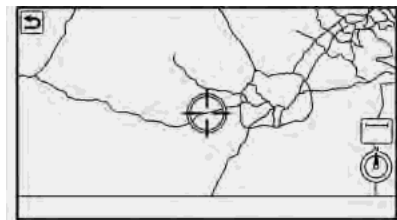

2D map:

When the map on the screen is touched, the cross pointer is displayed and the position touched is set as the center of the screen.

After moving the map, touch [] on the map screen to display the current location map screen.

INFO:

Touch [Slow] on the map screen to display the 8-directional key for fine adjustments of the location. Touch [Cancel] to cancel the fine adjustment mode.

Birdview™ (3D) map:

Touch the screen. The cross pointer is displayed at the center of the map. Touching the screen again will scroll the map toward the touched location.

Touch [←] or [→] to change the direction of the map.

Long touch:

Touch the direction to move to. The map continues to scroll while the screen is touched.

Drag:

Drags the map while the screen is touched.

Swipe/flick:

Swipe or flick the screen to scroll the map screen quickly.

CHANGING SCALE OF MAP

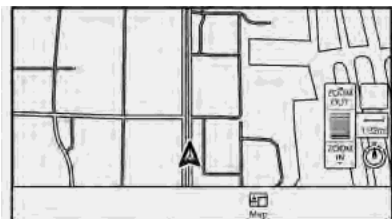

1. Touch [1/32mi].
The scale bar is displayed.
2. Touch [ZOOM IN] or [ZOOM OUT] to change the scale.

Pinch-in



To view a wider area, pinch-in the map screen.

Pinch-out



To view the map in detail, pinch-out the map screen.



INFO:

While driving, pinch-in and pinch-out operations are disabled.

Map scale

Map scale (map coverage) between 320 miles (640 km) and 1/64 mile (25 m) can be selected.

US Units	Metric Units
320 mi	640 km
80 mi	160 km
32 mi	64 km
8 mi	16 km
5 mi	10 km
2 mi	4 km
1 mi	2 km
1/2 mi	1 km
1/4 mi	500 m
1/8 mi	200 m
1/16 mi	100 m
1/32 mi	50 m
1/64 mi	25 m

3. Navigation



INFO:



Depending on the map scale, traffic information icons cannot be displayed on the map screen.

-  "Traffic information on map" (page 3-50)

CHANGING MAP

Changing map view and map orientation

The map view and the map orientation can be changed by touching [] / [] on the map screen.

The screen will change to North Up, Heading Up and Birdview™ each time [] / [] is touched.



North Up

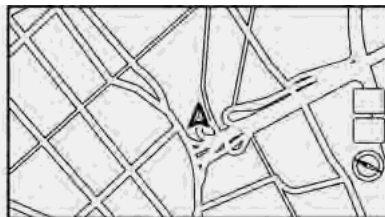

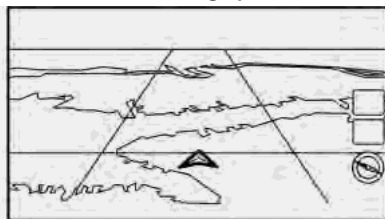

Heading Up



Birdview™

INFO:

- You can also change the map view from the map view settings screen.
 -  "Map view settings" (page 3-11)
- A long range map is available that displays a wider area in the direction the vehicle is moving in the Heading Up view.
 -  "Map view settings" (page 3-11)

Setting split screen

Two different maps can be displayed on a screen with the split screen setting.



1. Touch [] on the map screen.
2. Touch [Map View].
3. Touch [Change View].
4. Select [Split: 2D Map] or [Split: Birdview Map].

INFO:

The settings on the left split map can be changed from map view settings menu.

-  "Map view settings" (page 3-11)

MAP VIEW SETTINGS

The setup for the map view is performed from the Settings menu on the touch screen display.

1. Touch  on the map screen.
2. Touch [Map View].





INFO:

[Map View] can also be accessed from [Settings] on the Launch Bar.

 "Navigation settings" (page 3-60)

The following settings are available.

Menu item		Action	
[Change View]	[2D Map]	Display 2D map.	
	[Split: 2D Map]	Display 2D map on both left and right side of the split screen.	
	[Birdview (3D)]	Display 3D map.	
	[Split: Birdview Map]	Display 2D map on the left side and 3D map on the right side of the screen.	
[View Settings]	[Intersection]	Display the enlarged view of intersection on the left side of the screen during route guidance.  "Route guidance screens" (page 3-35)	
	[Turn List]	Display the turn list on the left screen when a route is set.  "Route guidance screens" (page 3-35)	
	[Full Map]	Display full map screen.	
[Map Settings]	[Map Orientation]	[North Up]	Select a map view to be applied to the map screen. [Map Orientation] is available only when 2D map is displayed.
		[Heading Up]	

3. Navigation

Menu item		Action
	[Long Range]	The position of the vehicle icon can be changed to view a wider area in the traveling direction. The vehicle icon is located slightly lower than the center of the screen. Long Range Map View is available only when the map view is "Heading Up".
	[Map Color]	Sets map color from color 1 - 4.
	[Map Text Size]	Sets the font size of text displayed on the map screen.
	[Large]	
	[Medium]	
	[Small]	
	[Birdview Angle]	Adjusts the Birdview™ angle using the adjust bar displayed on the left side of the screen. [Birdview Angle] is available only when 3D map is displayed.
	[North Up when Zoomed Out]	When this setting is ON, the orientation of the map is automatically changed to North Up when the widest map scale is selected.
	[Select Text to Display on Map]	[Place Names] Allows place names to be displayed on the map screen.
		[Facility Names] Allows facilities names to be displayed on the map screen.
		[Road Names] Allows road names to be displayed on the map screen.
	[Left Split Map Settings]	[Map Orientation] The map orientation for the left side of split screen can be selected from North Up or Heading Up.
		[Long Range] Long Range Map View is available only when the left side of split screen is in Heading Up mode. With this item turned on, the vehicle position icon on the left screen will be located slightly lower than the center of the screen so that a wider area in the traveling direction can be viewed.
		[Map Scale] Allows to change the scale of the map displayed on the left side of the split screen.

3. Navigation

Menu item		Action
	[Show all Freeway Exits on Route]	Turns on/off the freeway exit information display.
	[Auto. Show Turn List on Freeway]	The turn list can be set to on or off to be displayed automatically while driving on a freeway.
[Back to Map]		Back to the current location map.

3. Navigation

SETTING INFORMATION ON MAP





Some information on the map can be displayed or hidden.

Displaying map icons

Displays map icons of certain points of interest (such as restaurants and charging stations, etc.) on the map around the current vehicle location.

1. Touch [Settings] on the Launch Bar.
2. Touch [Navigation].
3. Touch [Map Icons].
4. Touch the preferred icon. The indicator of the selected icon illuminates.

Available setting icons

-  Restaurant
-  Charging Station
-  Hotel
-  ATM
-  Rest Area



INFO:

- [Map Icons] can also be accessed from  on the Map screen.
- The map icons are not displayed on the map screen when the map scale is set to 1/4 mile (500 m) or wider in the

2D and Birdview™ map.

- If brand icons are registered in the map data, the brand will be displayed on the map instead of the general map icons listed.

Displaying map scrolling information

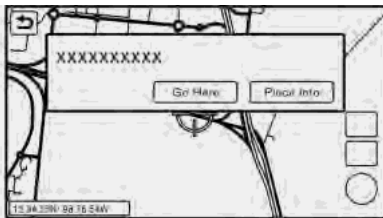

Information about the location, on which the center of the cross pointer is placed by scrolling on the map, can be set to be displayed.

1. Touch [Settings] on the Launch Bar.
2. Touch [Navigation] and touch [Others].
3. Touch [Map Scrolling Information].
4. Touch the preferred information item. The following information items are available.

- [Address Book Icons]
- [Destination/Waypoint Icons]
- [Show pop-up for POIs]
- [Latitude/Longitude Info]



INFO:

- When the settings are turned on, placing the cross pointer on the stored location icons, Destination/Waypoint icons or map icons will display the information in a pop-up window. The latitude/longitude of any point on the map where the cross pointer is located will be displayed on the bottom left corner of the map screen.
- When the [Go Here] is displayed on the pop-up window, destination can be set by touching it. Touch [Place Info] to display the place information. On the place information screen, touch [Show Map] to display the map around the location and touch [Call] to call the selected place if the key is available. When available, touch [Details] to show detail information of the place.

TRAFFIC INFORMATION ON MAP

With a subscription to SiriusXM Traffic, traffic information is displayed.

 "Traffic information on map"
(page 3-50)

Free Flow: Green arrow

Moderate traffic: Yellow arrow

Heavy traffic: Red

Section affected by serious traffic event:
Purple

The following traffic information icons may be displayed.

 : Accident

 : Closed road

 : Information

 : Road work

 : Slippery road

 : Weather

 : Incident

INFO:

Traffic icons are displayed in the scale level of 1/64 miles (25 m) - 5 miles (10 km) range. Some traffic icons are displayed only on the map at higher detail levels.

MAP MENU SCREEN





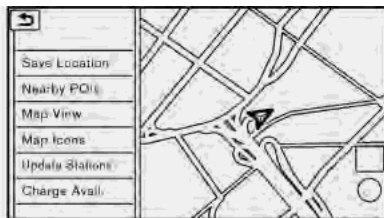

Touch  while the current location map screen or a scrolled map screen is displayed to display the menu corresponding to that screen.

This menu can be used to quickly access helpful functions, such as setting a destination and searching for points of interest nearby.

Current location map menu screen



If  is touched while the current location map screen is displayed, the following options are available.

- [Save Location]:
Stores the current vehicle location in the Address Book.
 "Storing location by moving map"
(page 3-53)
- [Nearby POIs]:
Searches for Points Of Interest near the current vehicle location.
 "Finding nearby place" (page 3-21)
- [Map View]:
Map view settings can be changed.
 "Map view settings" (page 3-11)
- [Map Icons]:
The map icons can be displayed or hidden by type.
 "Displaying map icons" (page 3-14)
- [Update Stations]:
Connect to the Nissan Data Center to update charging station around the current vehicle location.
 "Updating charging station information" (page 2-7)
- [Charge Avail.]:
Allows the driver to obtain the availability information of charging stations via Nissan Data Center.
 "Confirming charging station availability" (page 2-6)

3. Navigation

Scrolled location map screen

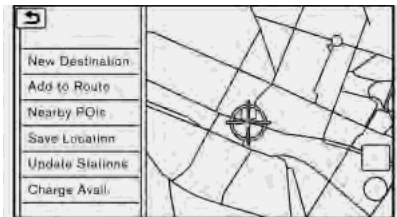

If [Map Menu] is touched while a scrolled map screen is displayed, the following options are available.

- [New Destination]:
Sets the map location pointed at by the cross pointer as a new destination.
☞ "Setting point on map" (page 3-28)
- [Add to Route]:
Adds the map location pointed at by the cross pointer as a destination or a waypoint to the route already set.
☞ "Setting destination or waypoint" (page 3-41)
- [Nearby POIs]:
Searches for Points Of Interest near the map location.
☞ "Finding nearby place" (page 3-21)

- [Save Location]:
Stores the map location pointed at by the cross pointer in the Address Book.
☞ "Storing location by moving map" (page 3-53)
- [Update Stations]:
Connect to the Nissan Data Center to update charging station around the point of the cursor.
☞ "Updating charging station information" (page 2-7)
- [Charge Avail.]:
Allows the driver to obtain the availability information of charging stations via Nissan Data Center.
☞ "Confirming charging station availability" (page 2-6)

SETTING DESTINATION

The destination you wish to drive to can be set for route guidance.

BASIC OPERATIONS

Displaying destination setting menu

There are several methods that can be used to set a destination. Select a preferred method for finding and setting a destination.

Touch [Navi] on the Launch Bar.













The destination screen will be displayed when a route is not set.

INFO:



If a route is set, the route menu screen will be displayed when [Navi] on the Launch Bar is touched. Touch [New Destination] to set a destination.

☞ "Route menu" (page 3-37)

Available destination setting methods:



Setting item	Action
[Street Address]	Searches for a destination by address.  "Finding address" (page 3-19)
[Charging Station]	Searches for charging stations located near the current vehicle location, destination, pointed place on map and city center. Nearby station availability can also be checked from this menu.  "Finding charging station" (page 3-19)
[Nearby Points of Interest]	Searches for points of interest near the current vehicle location, such as restaurants and charging stations, etc.  "Finding nearby place" (page 3-21)
[Points of Interest]	Searches for a destination from various categories of businesses or locations.  "Finding points of interest" (page 3-21)
[Home]	Searches for a route from the current location to the previously stored home location.  "Setting home as destination" (page 3-23)
[Destinations by Google™]	Sets a place searched by Google as a destination.  "Setting destinations by Google" (page 3-27)
[Address Book]	Searches for a destination from Address Book.  "Searching from address book" (page 3-24)
[Previous Destinations]	Searches for the destination from the previous destinations and a previous start point.  "Searching from previous destinations" (page 3-24)
[Intersection]	Sets an intersection as a destination.  "Setting intersection" (page 3-25)
[Phone Number]	Searches for a point of interest by a telephone number.  "Setting by phone number" (page 3-25)
[City Center]	Sets the center of a city as the destination.  "Setting city center" (page 3-26)
[Freeway Entrance/Exit]	Sets a freeway entrance/exit as a destination.  "Setting freeway entrance/exit" (page 3-26)

3. Navigation

[Stored Routes]	Sets a route from the stored route data.  "Setting from stored routes" (page 3-26)
[Send to Car]	Searches for a destination using Google Maps.  "Setting using Google Maps" (page 3-27)
[Route Planner]	Sets a route plan downloaded from the NissanConnect® Website.  "Setting using Route Planner" (page 3-28)



INFO:

- If the required battery power level may be insufficient when the destination is set, the system provides guidance to any available charging stations.
- If setting a destination when the Li-ion battery power level may be insufficient to reach the set destination, the information for charging stations is displayed, allowing you to set a charging station as the destination.
- After setting a destination, the location of the destination can be adjusted and the location can be stored in the Address Book, etc.
 "Options before starting the route guidance" (page 3-29)
- The destination can be deleted.
 "Canceling Route" (page 3-40)

Specifying region

With some destination setting methods, state/province and city can be specified prior to searching for destination locations.

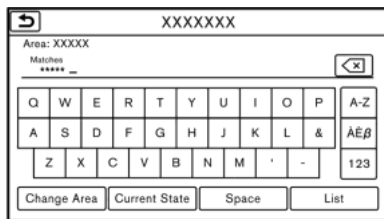

1. Touch [Navi] on the Launch Bar.
2. Touch the desired search method.
3. Touch [State/Province] or [City] if displayed.
4. Enter the name of the state, province or city and then touch [List]. A list screen is displayed.

5. Touch the preferred state, province or city from the list.



INFO:

- When the system is restarted, the state and province in which the vehicle is recognized by the GPS to be located will be set automatically as a state and province for location search.
- Touch [Change Area] to change the area for conducting the location search.
- Touch [Current State] to search for the destination within the state or province where the vehicle is currently located.
- Touch [Space] to enter a space between letters.
- After touching [City], touching [Last 5 Cities] can display the last 5 cities set as destinations.

- In some cases, when a city name has been entered, the number of matching destinations in the “Matches” column may be different from the number displayed on the list screen. If this occurs, enter more characters to further reduce the number of matches.
- It is not possible to search for a route from the continental United States or Canada to Hawaii, Virgin Islands, Puerto Rico, etc.

FINDING ADDRESS

Searches for a destination by address.

1. Touch [Navi] on the Launch Bar.
2. Touch [Street Address]. The street address input screen is displayed.

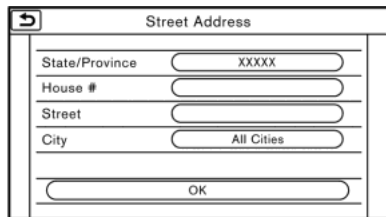

3. Input the street address.

- Touch [State/Province] to enter the state or province name.
 - Touch [House #] to enter the house number. If the house number is not available, touch [No House #].
 - Touch [Street] to enter the street name. After finishing the entry, touch [List]. A list of streets is displayed.
 - Touch [City] to enter the city name. If the city name is not available, touch [All Cities].
4. Enter the state/province, house number, street and city of the destination and then touch [OK]. The route is displayed.
 5. Touch [Start] to start route guidance.



Voice command

1. Push <  > located on the steering wheel.
2. After the tone sounds, speak a command.

Use the following voice command to search for a destination by address:

“Street Address”*

*: This voice command operation is available only when the language setting is in

English.

FINDING CHARGING STATION

Searches for charging stations.

1. Touch [Navi] on the Launch Bar.
2. Touch [Charging Station]. A list of search conditions is displayed.

Search conditions:

- [Near Current Location]
Displays a list of charging stations that are near the current vehicle location.
- [Near Destination]
Displays a list of charging stations that are near the destination, when a destination has been set.
- [Near Scroll Position]
Displays a list of charging stations near location where the cross pointer is located on the map.
- [Near City Center]
Displays a list of charging stations when a city name is entered.
- [Near Another POI]
Displays a list of facilities equipped with charging station when POI is selected.

3. Navigation

- [Nearby Charging Availability]
Displays a list of nearby charging stations and icons that show their current availability by connecting to Nissan Data Center.
☞ "Confirming charging station availability" (page 2-6)

3. Select preferred searching conditions.

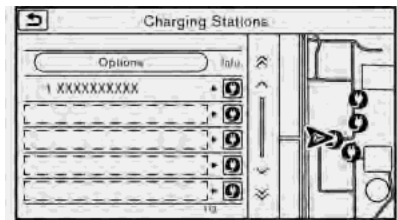

4. Select a charging station from the list.



INFO:

- Touch [Options] to select from the following options. Available items may vary depending on certain conditions.
 - [Show Along Route]:
Shows charging stations located along the route to destination.
 - [Show Quick Charging Stations Only]:
Shows charging stations with quick charger.
 - [Available Spot Only]:
Shows charging stations that are available.
 - [Free Only]:
Shows charging stations that are free of charge.
 - [Select Payment System]
Select payment method and the usable charging stations are displayed.
- Touch [📍] or [📄] on the list to view charging station information. On the place information screen, touch [Show Map] to display the map around the location and touch [Call] to call the selected place if the key is available. When available, touch [Details] to show detail information of the place.

5. Touch [Yes] to confirm the message displayed on the screen.
6. Touch [Start] to start the route guidance.



NOTE:

Equipment that is displayed on the charging station information screen is not necessarily compatible with a LEAF. Be sure to check whether equipment can be used with a LEAF beforehand.



INFO:

Charging station search menus can also be accessed with the following procedure.

- Touch [Nearby Station] in the Zero Emission menu.
☞ "Zero Emission menu screen" (page 2-2)



Voice command

1. Push <🔊> located on the steering wheel.
2. After the tone sounds, speak a command.

Use the following voice command to search for a destination by address:
"Charging Station"

FINDING NEARBY PLACE

A facility located near the current vehicle location can be set as the destination.

1. Touch [Navi] on the Launch Bar.
2. Touch [Nearby Points of Interest]. The category list is displayed.

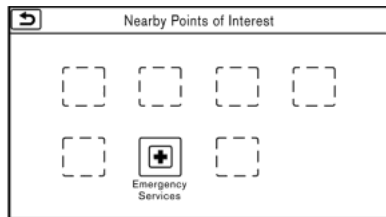

3. Select [Emergency Services] for example.
4. Select preferred category from the sub category list.

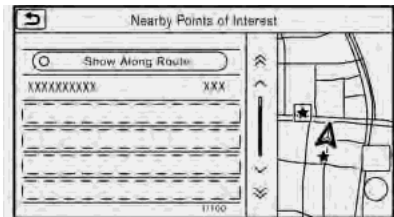

5. Touch the preferred destination from the list. The position of the selected location is displayed in the preview on the touch screen display.



INFO:

- If the suggested route is already set, by touching [Show Along Route] on the touch screen display, the system displays only the facilities located along the route.
 - A maximum of 100 facilities can be displayed on the list screen.
6. Touch [Start] to start route guidance.



INFO:

- Depending on the type of facility, a message asking if you have checked the facility availability may be displayed. Touch [Yes] or [No] after reading the message.
- You can also set the destination by touching [Map Menu] when scrolling the map and selecting [Nearby POIs] from the menu.
- Nearby Points of Interest category list can be customized from [Customize Nearby POIs].

 "Navigation settings" (page 3-60)



Voice command

1. Push <  > located on the steering wheel.
2. After the tone sounds, speak a command.

Use the following voice command to set a nearby place as a destination:

"Nearby"

FINDING POINTS OF INTEREST

This allows you to find a facility by name or by category. Specify the region and city of the destination to find it more quickly.



NOTE:

Locations and business hours of facilities are subject to change, which may not be reflected in the map data. Double-check this information before you go to an emergency facility to ensure that you can receive the proper support. Otherwise, you may not receive emergency help when you arrive at the destination.

A confirmation message also appears on the navigation screen. Follow the displayed instructions and check the items required.

3. Navigation

Searching for a specific name

1. Touch [Navi] on the Launch Bar.
2. Touch [Points of Interest].
3. Touch [Spell Name]. A character input screen is displayed.

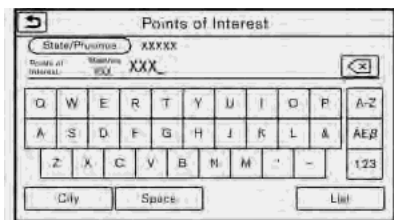

INFO:

Touch [City] and touch [Last 5 Cities] to display the last 5 cities recently set as destinations.

4. Enter the name of the destination facility. After finishing the entry, touch [List]. A list screen is displayed.
5. Touch the preferred destination facility from the list.

Sorting and filtering:

- [By Distance]:
Shows a list of facilities that are near the current vehicle location.

- [New Category]:
Displays the list that summarizes the listed names into categories. Select the category to narrow down the search.



INFO:

- Touch [i] on the list screen to display the detailed information about the POI that is selected on the touch screen display.
 - To search for a POI with two or more words, touch [Space] to enter a space between each word.
6. A map of the selected place is displayed. Touch [Start] to start route guidance.



INFO:

- After setting a destination, the location of the destination can be adjusted and the location can be stored in the Stored Location, etc.
 "Options before starting the route guidance" (page 3-29)



Voice command

1. Push <  > located on the steering wheel.
2. After the tone sounds, speak a command.

Use the following voice command to search for Points of Interest from a facility name:

"Points of Interest <POI Name>"

*: This voice command operation is available only when the language setting is set to English.

Searching Points of Interest by category

1. Touch [Navi] on the Launch Bar.
2. Touch [Points of Interest]. The main category menu is displayed.
3. Touch the main category. The subcategory list is displayed.
4. Touch the subcategory. Narrow down condition screen is displayed.
5. Touch the narrow down category.

Search conditions:

- [Sorted By Name]:
Enter the name of the facility

- [Select a City]:
Input the city to narrow down the target city.
- [Near Current Location]:
Facilities near the current vehicle location are displayed in a list.
- [Near Destination]:
When the destination is set, this indicates a list of facilities around the destination.

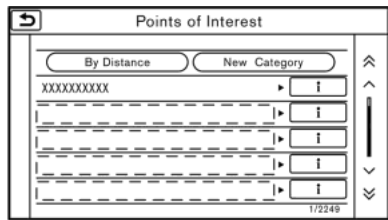

6. Touch the preferred destination facility from the list.
Touch [Start] to start route guidance.



INFO:

- Subcategories may not be displayed depending on the selected main category.
- If there is no nearby POI, a message asking whether to search from an extended area will be displayed. When [Yes] is selected, the system starts to search for POI in a wider area.
- Touch [i] on the list screen to display the detailed information about the POI that is selected on the touch screen display.
- Touch [By Distance] to sort the list by the distance. Touch [New Category] to select a different POI category.



Voice command

1. Push < > located on the steering wheel.
2. After the tone sounds, speak a command.

Use the following voice command to search for Points of Interest from category:

"POI Category"

SETTING HOME AS DESTINATION

The home location can be set as the destination if the home location is stored in advance. This function is especially useful when searching for a route to return to the home location.

1. Touch [Navi] on the Launch Bar.
2. Touch [Home].



INFO:

If the home location is not stored yet, the system will display a message asking if you wish to store a home location. Touch [Yes] to store the home location.

 "Storing home location"
(page 3-52)

3. An entire route to the destination is displayed. Touch [Start] to start route guidance.



Voice command

1. Push < > located on the steering wheel.
2. After the tone sounds, speak a command.

Use the following voice command to set home as the destination:

"Go Home"

3. Navigation

SEARCHING FROM ADDRESS BOOK

Locations frequently visited can be stored in the Address Book and reused to set destinations.

 "Storing location" (page 3-52)

1. Touch [Navi] on the Launch Bar.
2. Touch [Address Book].

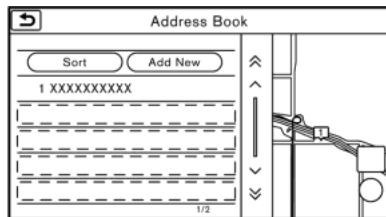

3. Touch the preferred location from the list.



INFO:

- Selecting [Sort] displays a list of various sort functions.
- [Sorted By Number]:
The Address Book entries are displayed in ascending numerical order.

- [Sorted By Name]:
The Address Book entries are displayed in alphabetic order.

- [Sorted By Icon]:
By selecting a particular icon, a list that contains only the Address Book entries associated with that icon is displayed.

- [Sorted By Group]:
By selecting a particular group (family, friends, leisure, etc.), the selected group is displayed at the top of the list.

- Touch [Add New] to add a new location.
4. The selected destination is displayed.
Touch [Start] to start route guidance.



Voice command

1. Push <  > located on the steering wheel.
2. After the tone sounds, speak a command.

Use the following voice command to set a destination from the Address Book:

"Address Book"

SEARCHING FROM PREVIOUS DESTINATIONS

A previous destination and a previous start point can be set as the destination.

Up to 100 previous destinations will be automatically stored. If the number of previous destinations exceeds 100, the oldest one is automatically deleted and the new destination is added.

1. Touch [Navi] on the Launch Bar.
2. Touch [Previous Destinations]. A list screen is displayed.
3. Touch the previous destination or a previous start point from the list.
4. Touch [Start] to start route guidance.



Voice command

1. Push <  > located on the steering wheel.
2. After the tone sounds, speak a command.

Use the following voice commands to display the previous destinations/start point list:

"Previous Destinations"

"Previous Start Point"

SETTING INTERSECTION

It is possible to set an intersection of any two streets as the destination and have the system calculate a route.

1. Touch [Navi] on the Launch Bar.
2. Touch [Intersection]. Intersection screen is displayed.

3. Input the Intersection.
 - Touch [State/Province] to enter the state or province name if necessary.
 - Touch [City] to enter the city name.
 - Touch [1st Street] to enter the first street name. After finishing the entry, touch [List]. A list screen is displayed.
 - After 1st street information is entered, touch [2nd Street] to enter the second street name. After finishing the entry, touch [List]. A list screen is displayed.

4. Enter the state/province, city, and street of the destination and then touch [OK]. The route is displayed.
5. The selected destination is displayed at the center of the map. Touch [Start] to start route guidance.



Voice command

1. Push < > located on the steering wheel.
2. After the tone sounds, speak a command.

Use the following voice command to set an intersection as destination:

“Intersection”*

*: This voice command operation is available only when the language setting is set to English.

SETTING BY PHONE NUMBER

If the phone number of a facility is known, it is possible to search for a facility by entering the phone number.



INFO:

- If the area code of the specified telephone number does not exist in the map data, the system cannot search for the location.
 - Only the locations included in the database in the map data can be searched for by phone number. Residential phone numbers cannot be used to search for a location.
1. Touch [Navi] on the Launch Bar.
 2. Touch [Phone Number]. The telephone number input screen is displayed.
 3. Enter the telephone number including the area code. After finishing entry, touch [OK].
 4. The selected destination is displayed. Touch [Start] after confirming the location of the displayed destination.



INFO:

If there are more than one location registered for the phone number, a list screen is displayed. Touch an item on the list to select a preferred location.

3. Navigation

SETTING CITY CENTER

It is possible to set the center of a specified city as a destination.

1. Touch [Navi] on the Launch Bar.
2. Touch [City Center]. A character input screen is displayed.
3. Enter the name of the city and touch [List]. A list screen is displayed.



INFO:

Touch [Last 5 Cities] to display the last 5 cities recently set as destinations.

4. Touch the preferred destination from the list.



INFO:

Touch [By Distance] to sort the list by the nearest distance. Touch [Sorted By Name] to sort the list by the alphabetic order.

5. The selected destination is displayed on the map. Touch [Start] after confirming the location of the displayed destination.



Voice command

1. Push < > located on the steering wheel.
2. After the tone sounds, speak a command.

Use the following voice command to set city center as a destination:

“City Center”*

*: This voice command operation is available only when the language setting is in English.

SETTING FREEWAY ENTRANCE/ EXIT

It is possible to set the destination to an entrance or exit of a freeway.

1. Touch [Navi] on the Launch Bar.
2. Touch [Freeway Entrance/Exit] to display the keyboard input screen.
3. Enter the name of the freeway. After finishing entry, touch [List].
4. Touch the preferred freeway.

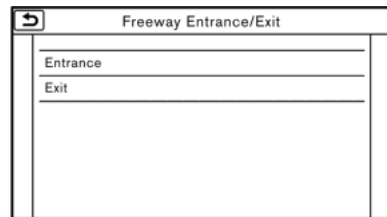

5. Touch [Entrance] or [Exit]. A list screen is displayed.
6. Touch the preferred destination from the list. The selected location is displayed in the preview on the touch screen display.



INFO:

- Touch [By Distance] to sort the list by the nearest distance.
7. Touch [Start] to start route guidance.

SETTING FROM STORED ROUTES

It is possible to select a preferred route from the stored routes.

1. Touch [Navi] on the Launch Bar.
2. Touch [Stored Routes]. A list screen is displayed.
3. Touch the preferred route from the list.

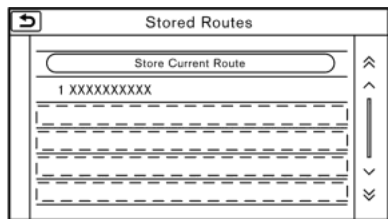

4. The entire route is shown on the map. Touch [Start] to start route guidance.

INFO:

- The stored route only includes locations (destination and waypoints) and route calculation conditions, not the route itself. Therefore, when the destination is set using a stored route, a different route may be suggested if the current vehicle location is different from the one when the route was stored.
 - To store the current route, touch [Store Current Route]. A route can be stored only when it includes one or more waypoints.
-  "Storing route" (page 3-53)

SETTING USING GOOGLE MAPS

It is possible to search for a location using Google maps, and to download the information to set the destination via the Nissan Data Center.

1. Touch [Navi] on the Launch Bar.
2. Touch [Send to Car].
3. Select the preferred destinations from the list. The position of the selected location is displayed in the preview on the right side of the screen.

INFO:

Select [Download] to update the list information. The system connects to the Nissan Data Center and the destination list will be downloaded.

4. The select destination is displayed. Touch [Start] after confirming the location of the displayed destination. The system sets the selected location as the destination and starts calculating a route.

INFO:

Refer to the NissanConnect® Website for details on destination setting using Google Maps.

SETTING DESTINATIONS BY GOOGLE

It is possible to set a destination by downloading the place information searched on Google by entering keywords.

1. Touch [Navi] on the Launch Bar.
2. Touch [Destinations by Google™]. A list of search conditions is displayed.

Search conditions:

- [Near Current Location]
Narrows down the search area to near the current vehicle location.
- [Near Destination]
Narrows down the search area to near the destination (when a route is set).
- [Near Scroll Position]
Narrows down the search area to near the location selected on the map.
- [Near City Center]
Narrows down the search area to a

3. Navigation

specified city center.

Enter the city name within which you wish to search for the place.

3. Enter the keyword and then touch [Search]. A list of the searched items downloaded from Google is displayed.



INFO:

The system downloads the information searched by Google via the TCU (Telematics Control Unit). Use of NissanConnect® EV and Services features is dependent upon a valid subscription and the telematics device being in operative condition, as well as cellular connectivity, navigation map data and GPS satellite signal reception being available.

SETTING USING ROUTE PLANNER

It is possible to set a route according to the route plan created in advance at the NissanConnect® Website.

1. Touch [Navi] on the Launch Bar.
2. Touch [Route Planner].
3. Touch a preferred route plan.



INFO:

Select [Download] to update the list information.

4. Touch [Start] after confirming the location of the displayed.



INFO:

Refer to the NissanConnect® Website for details on the Route Planner.

SETTING POINT ON MAP

It is possible to set a location scrolled to on the map as the destination and have the system calculate a route.

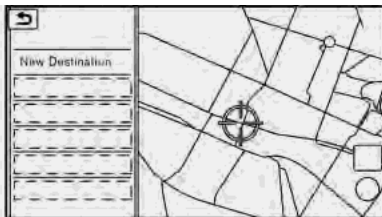

1. Scroll the map, place the cross pointer over the preferred location, and touch



INFO:

The point on the blinking road where the center of the cross pointer is located can be set as a destination.

2. Touch [New Destination].
3. The entire route is shown on the touch screen display. Touch [Start] to start route guidance.



INFO:

If a point on a freeway is set as the destination, a confirmation message is displayed.

SETTING WITH NISSANCONNECT® EV AND SERVICES

It is possible to set the destination using the NissanConnect® EV and Services features.

1. Touch "NissanConnect® EV and Services menu" (page 5-11)



INFO:

Use of NissanConnect® EV and Services features is dependent upon a valid subscription and the telematics device being in operative condition, as well as cellular connectivity, navigation map data and GPS satellite signal reception being avail-

able.

Setting from information feeds

If the downloaded NissanConnect® EV and Services information feed has location data, you can set it as a destination. It is also possible to use NissanConnect® EV and Services features such as “Send to Car” or “Route Planner”, etc. to set a destination.

1. Touch [Info] on the Launch Bar.
2. Touch [NissanConnect EV & Services].
3. Touch [All Information Feeds]. A list screen is displayed.
4. Touch a preferred folder. A list of information feeds is displayed.
5. Touch a preferred information feed.

For details of the services and settings, refer to the NissanConnect® Website or contact the NissanConnect® support line.

NissanConnect® Website:

For U.S.

www.NissanUSA.com/connect

For Canada

www.Nissan.ca/NissanConnect
(English)

www.Nissan.ca/NissanConnect/fr
(French)

NissanConnect® support line:

1-877-664-2738

INFO:

The methods for setting a destination differ depending on the specific service (Roadside Assistance Service, Assisted Search, Destination Download, Connected Search, etc.) and NissanConnect® EV and Services may be updated during ownership. Please see the NissanConnect® Website for the latest features and services, as well as the most up-to-date user guide.

SEARCHING BY USING VOICE MENU BUTTON ON MAP

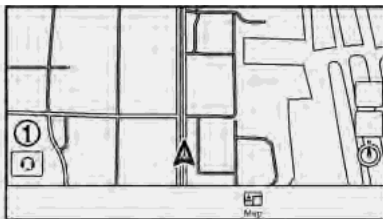

It is possible to set a destination by touching the Voice Menu button ① on the map. You can choose from the options provided by the voice guidance and speak your choice, or ask the NissanConnect® EV and Services Response Specialists directly

to search for your destination.

 “Connecting to Interactive Voice Menu” (page 5-12)

OPTIONS BEFORE STARTING THE ROUTE GUIDANCE

Before starting the route guidance, select menus for route details to modify the route, preview the turn list, or store the route.

There are two types of route details menu that are displayed depending on the conditions and the methods used to set the destinations.

Example 1:

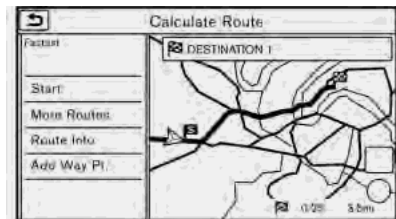

- [Start]: Starts route guidance to the selected destination.
- [More Routes]: A route type can be selected by touching the preferred item and then

3. Navigation

touch [OK].

- [Energy-Saving] (green)
Selects a route that is most energy saving.
- [Fastest] (purple)
Selects a route that is shortest in time.
- [Min. FWY] (orange)
Selects a route with minimum use of freeways.
- [Short. Dist.] (pink)
Selects a route that is shortest in distance.
- [Route Info]:
Route Information such as turn list and scrolled map can be displayed. The route can also be saved for future use.
- [Add Way Pt.]:
Route can be edited by adding a destination or a waypoint.
 - If a waypoint is added, 3 alternative routes cannot be selected.
 - It is possible to edit or add a destination or waypoints to the route that is already set.
 "Editing route" (page 3-40)

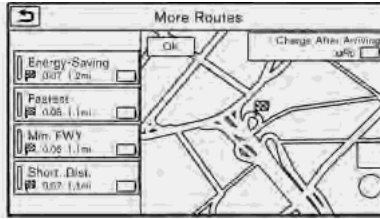

INFO:

- Battery power information is displayed on the screen after [More Routes] is touched. The remaining battery power estimation function cannot be used to confirm condition changes that arise after driving starts. Utilize the function as a reference when selecting driving routes.
- After starting to drive, refer to the driving range on the meter and perform battery charging allowing for some leeway.
- In the following instances, the actual battery power may differ from the remaining battery power estimation.
 - Frequent repetition of sudden acceleration and sudden braking

- Change of air conditioner operating conditions
- Change of traffic conditions and driving routes that differ from the one used for the estimation
- Strong wind, cold, and snow weather conditions
- Tires that do not comply with specifications, low air pressure tires, worn tires, studless tires, and others.
- Decreased capacity of the Li-ion battery
- Installation of equipment that does not comply with specifications (carriers and others)
- Choosing different route search conditions in [More Routes] may not always generate results search for different routes.

Example 2:



- [Start]: Starts route guidance to the selected destination.
- [Route Details]: Displays information of the route and allows the route to be edited. The menu shown in Example 1 is displayed.
- [Move Location]: Displays a map screen and allows the location of the destination to be adjusted.
- [Add to Route]: Adds a location to the route previously set.
- [Save Location]: Saves the location in the Address Book.
- [Details]: Displays detailed information of the destination. Touch [Show Map] to display the map around the destination. Touch [Call] (when available) to make a phone call to the facility set as a destination.

ROUTE GUIDANCE

ABOUT ROUTE GUIDANCE

After setting the route, select [Start] to start the route guidance.

Throughout the route guidance, the system navigates you through the guide points using visual and voice guidance.



WARNING

- **The navigation system's visual and voice guidance is for reference purposes only. The contents of the guidance may be inappropriate depending on the situation.**
 - **Follow all traffic regulations when driving along the suggested route (e.g., one-way traffic).**
-  "Route guidance" (page 9-8)

Voice guidance during route guidance

Basics of voice guidance:

Voice guidance announces which direction to turn when approaching an intersection for which a turn is necessary.



INFO:

- There may be some cases in which voice guidance and actual road conditions do not correspond. This may occur because of discrepancies between the actual road and the information on the map data, or may also be due to the vehicle speed.
- In case voice guidance does not correspond to the actual road conditions, follow the information obtained from traffic signs or notices on the road.
- Route guidance provided by the navigation system does not take carpool lane driving into consideration, especially when carpool lanes are separated from other road lanes.
- The system will announce street names when the system language is set to English. Street names are not announced when the system is set to French or Spanish.



INFO:

- When approaching a guide point (intersection or corner), destination, etc. during route guidance, voice guidance announces the remaining distance and/or turning direction. Push and

3. Navigation

hold **<MAP>** to repeat voice guidance.

- Voice guidance settings can be changed from [Intersection Guidance Settings].

 "Guidance settings" (page 3-45)

Example of voice guidance:

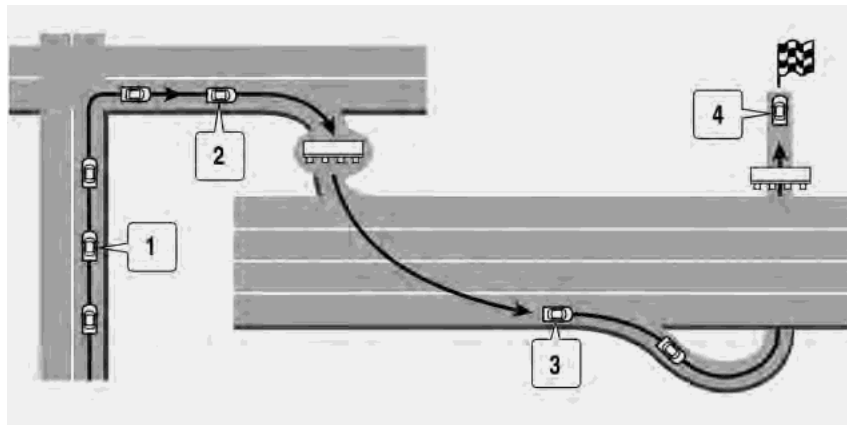

- ① "In about a quarter mile (400 meters), right (left) turn."

"Right (left) turn ahead."

- ② "In about a quarter mile (400 meters) freeway entrance on your right onto (road number and direction)."

"Freeway entrance on your right onto (road number and direction)."

- ③ "In about 1 mile (2 kilometers), exit on your right."

"Exit on your right."

- ④ "You have arrived at your destination."

Directions will differ, depending on the road type.



INFO:

Distances may vary, depending on the vehicle speed.

Notification of intersection on ordinary road:

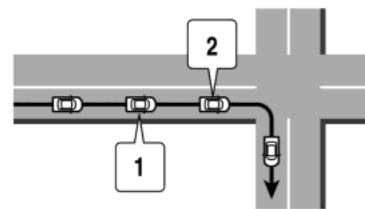

1. "In about a quarter mile (400 meters), right (left) turn."

2. "Right (left) turn ahead."

Notification of consecutive intersections on ordinary roads:

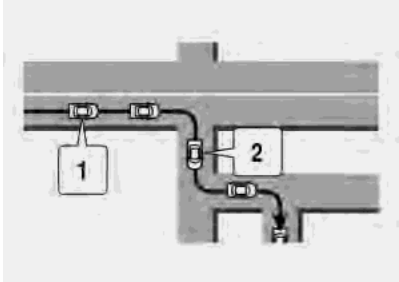

When the road has three or more consecutive intersections ahead, voice guidance will announce the following.

1. "In about a quarter mile (400 meters), right (left) turn, then in about a quarter mile (400 meters) left (right) turn."
2. "Left (right) turn ahead, then in about a quarter mile (400 meters) right (left) turn."

Notification of freeway entrance:

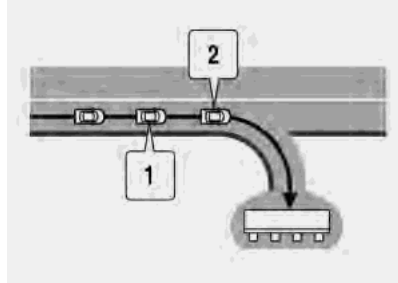

1. "In about a quarter mile (400 meters) freeway entrance on your right onto (road number and direction)."
2. "Freeway entrance on your right onto (road number and direction)."

3. Navigation

Notification of freeway junction:

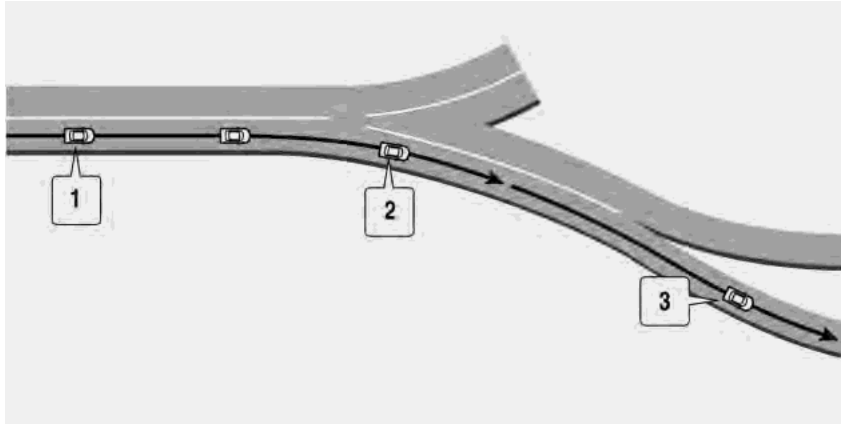

1. "In about 1 mile (2 kilometers), keep to the right (left) onto (road number and direction), then in about a quarter mile (400 meters) keep to the right (left)."
2. "Keep to the right (left) onto (road number and direction), then in about a quarter mile (400 meters) keep to the right (left) onto (road number and direction)."
3. "Keep to the right (left) onto (road number and direction)."

Notification of freeway exit:

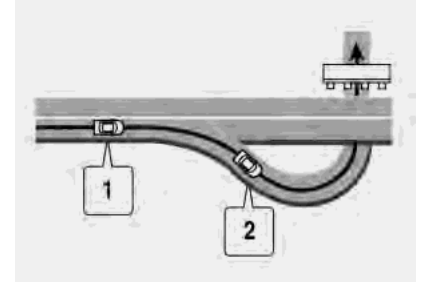

1. "In about 1 mile (2 kilometers), exit on your right."
2. "Take the second exit on your right."

Notification when approaching destination:

Ordinary road:

When approaching the destination, voice guidance will announce, "You have arrived at your destination." To reach your final destination, refer to the map screen.

Dark green road:

After passing the last turning point on a suggested route, voice guidance will announce, "The route to your destination includes roads through incomplete map areas. Voice guidance will not be provided

in these areas.” When approaching the endpoint of the suggested road, voice guidance will announce, “Entering the road with incomplete map data. The route will be shown in a different color in this area. Please follow traffic regulations.”



INFO:

Actual voice guidance may vary depending on road conditions and information registered in the system.

Route guidance screens

Various guidance screens are displayed on the touch screen display during route guidance.

The settings of the guidance screens can be changed.

 “Map view settings” (page 3-11)

Route guidance on map screen:

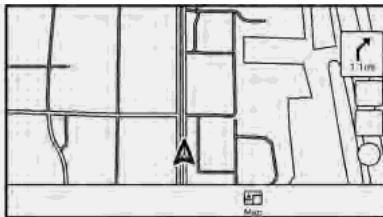

When route guidance starts, the small turn arrow and the distance to the next guide point are displayed in the upper right corner of the map screen. This arrow indicates the turning direction at the next guide point (corner or intersection). The distance is also displayed. When approaching a guide point, enlarged intersection view is displayed. Also, there may be cases where next street names are announced.

Enlarged intersection view:

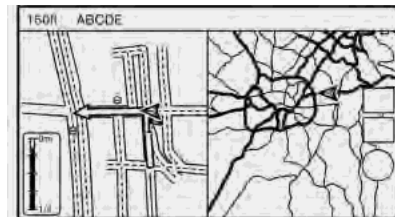

When approaching a guide point, the system automatically changes to the split screen and shows an enlarged view of the intersection on the left screen. To switch to the full map screen while the enlarged intersection view is displayed, push **<MAP>**. The distance to the guide point and the name of the next street to drive on are displayed on the top of the screen.

3. Navigation

Junction guidance:

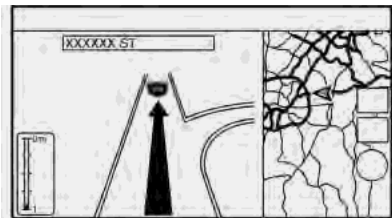

While driving on a freeway, when the vehicle is approximately 1 mile (approximately 2 km) from a junction, the system automatically switches to the split screen and displays an enlarged view of the junction on the left screen. After the vehicle passes the junction, the system automatically returns to the full screen mode. To switch to the full map screen while the enlarged junction view is displayed, push **<MAP>**.

Turn list:

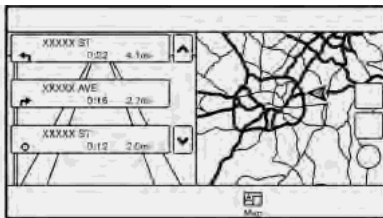

When [Turn List] in the view settings menu is turned on, a turn list can be displayed on the left side of the screen. To switch to the full map screen, push **<MAP>**.

☞ "Map view settings" (page 3-11)

The left screen automatically switches to an enlarged view of the intersection when approaching a guide point.

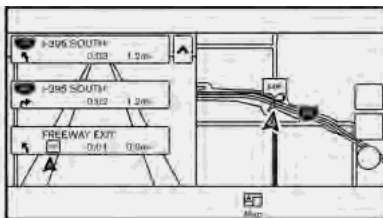

When [Turn List] and [Show all Freeway Exit on Route] are turned on and the route includes a freeway or toll road, all exits

along the route and its exit information will be shown in the turn list. The exit information is shown as icons.

With [Auto. Show Turn List on Freeway] turned on, the turn list will appear automatically when driving on freeways.

☞ "Map view settings" (page 3-11)

Selecting a waypoint from the exit information list:

When exit information is displayed on the turn list, a waypoint to a facility located near the freeway exit can be set as a waypoint. The facility categories that are not shown with an icon on the turn list cannot be selected.

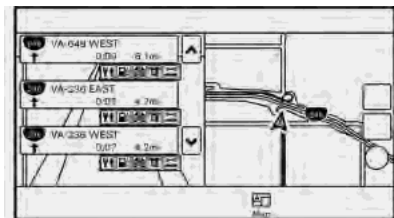

1. Touch the exit where the exit information icon is displayed. The category list screen is displayed.
2. Touch the landmark category. A list of facilities located near the freeway exit is displayed.

 **INFO:**

The facility categories that are not shown with an icon cannot be selected.

3. Touch the preferred facility for the waypoint.
4. The waypoint is set, and the route search is performed.
 -  "Options before starting the route guidance" (page 3-29)
5. Touch [Start] to start the route guidance.

ROUTE MENU



WARNING

Always stop the vehicle in a safe location before modifying the route conditions. Modifying the route conditions while driving may cause an accident.

During route guidance, the route conditions can be modified and the route information can be confirmed. Set route conditions according to your personal preference.

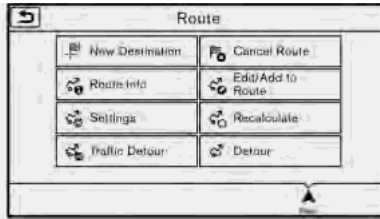







Touch [Navi] on the Launch Bar.

Route menu screen is displayed when a destination is already set.

3. Navigation

Available settings

Setting item		Action	
[New Destination]		Sets the new destination.  "Setting new destination" (page 3-40)	
[Cancel Route]		Cancels the current route guidance.	
[Route Info]	[Turn List]	Displays the details of the suggested route.	
	[Simulation]	Simulates the route guidance. This function provides a detailed image of the route with voice guidance.  "Confirming route" (page 3-40)	
	[Store Route]	A calculated route can be stored. A route can be stored only when it includes at least one waypoint.	
	[Map Scroll]	A map scrolled further will be displayed.	
[Edit/Add to Route]		A destination or waypoint can be edited to a route that has already been set.  "Editing route" (page 3-40)	
[Settings]	[Guidance Settings]	[Guidance Voice]	Activates or deactivates voice guidance.
		[Guidance Volume]	Adjust the volume level of voice guidance.
		[Traffic Announcement]	Activates or deactivates the traffic information announcements.
	[Route Settings]	[Basic Route Type]	Set the route search conditions.
		[Other Routing Choices]	 "Route Settings" (page 3-47)
	[Show Destination]	[Move Location]	Displays a map screen and allows the location of the destination to be adjusted.
		[Nearby POIs]	Search for points of interest near the current vehicle location, such as restaurants and charging stations, etc. The location can be set as a waypoint.
		[Save Location]	Save the destination in the Address Book.

[Recalculate]	Manually search for the route again after changing the search conditions, etc. and have the system calculate a route.  "Recalculating route" (page 3-43)
[Traffic Detour]	Set the route search condition to detour traffic jam and traffic accident.  "Searching for detour route using traffic information" (page 3-43)
[Detour]	A detour of a specified distance can be calculated.  "Setting detour route" (page 3-44)

**INFO:**

A SiriusXM Travel Link or SiriusXM Traffic subscription is necessary to receive SXM information services.

3. Navigation

SETTING NEW DESTINATION

When the destination is already set, new destination can be set.

1. Touch [Navi] on the Launch Bar.
2. Touch [New Destination].
3. Touch the preferred destination setting method.
☞ "Setting destination" (page 3-16)

INFO:

You can also set a waypoint with this operation.

CANCELING ROUTE

It is possible to delete a destination and all waypoints that have already been set.

1. Touch [Navi] on the Launch Bar.
2. Touch [Cancel Route].
3. A confirmation message is displayed. Touch [Yes] to delete the currently set destinations and waypoints.

INFO:

The deleted destination and waypoints cannot be reactivated.

CONFIRMING ROUTE

The route information can be confirmed and the suggested route simulation can be performed.

1. Touch [Navi] on the Launch Bar.
2. Touch [Route Info].

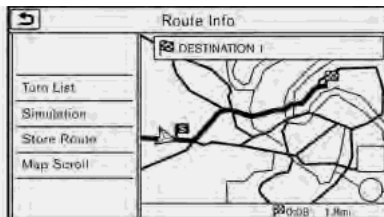

3. Touch the preferred item.

Available items

- [Turn List]: Displays the details of the suggested route guidance.
- [Simulation]: Simulate the route guidance. This function provides a detailed image of the route with voice guidance. Touch the following keys for operation.

 : Pauses the simulation.

 : Resumes the simulation.

 : Ends the simulation.

- [Store Route]: A calculated route can be stored. A maximum of 5 routes can be stored. The stored routes can easily be recalled for future use.
- [Map Scroll]: Displays a map screen where the location of the destination can be confirmed.

EDITING ROUTE

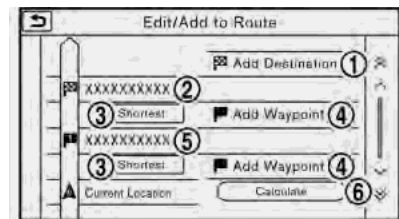

1. Touch [Navi] on the Launch Bar.
2. Touch [Edit/Add to Route].
3. Edit the following settings and touch [Calculate].

Available settings

- ① [Add Destination]: Touch to add a new destination.

- ② **Current destination:**
Touch to edit or delete the destination.
☞ "Editing/deleting destination or waypoint" (page 3-41)
- ③ **Condition for calculating a route to the destination/waypoint:**
Changes the conditions for route calculation.
☞ "Changing route calculation conditions" (page 3-42)
- ④ **[Add Waypoint]:**
Touch to add a waypoint.
☞ "Setting destination or waypoint" (page 3-41)
- ⑤ **Current waypoint:**
Modifies or deletes the waypoint.
☞ "Editing/deleting destination or waypoint" (page 3-41)
- ⑥ **[Calculate]:**
After editing the route, the system recalculates a route with new conditions.

Setting destination or waypoint

A destination or waypoint can be added to a route that has already been set. Up to 5 waypoints besides one destination can be set.

1. Touch [Navi] on the Launch Bar.
2. Touch [Edit/Add to Route].

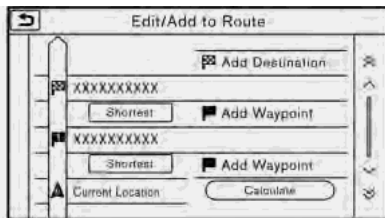

3. Touch [Add Destination] or [Add Waypoint].

INFO:

If [Add Destination] is selected, the current destination changes to a waypoint.

4. Set a destination or waypoint. The method of searching for a destination or waypoint is the same as the one for a destination.
☞ "Setting destination" (page 3-16)

5. Touch [Add to Route] to add the location to the route.
6. The route information with the selected location added to the route is displayed. Adjust the route calculation conditions as necessary.
☞ "Changing route calculation conditions" (page 3-42)
7. Touch [Calculate] to confirm the route change. The route will be recalculated.

INFO:

- The prior route will be deleted automatically.
- Destinations or waypoints can also be added from the Map Menu.
☞ "Scrolled location map screen" (page 3-16)

Editing/deleting destination or waypoint

A destination or waypoint that has already been set can be modified or deleted.

1. Touch [Navi] on the Launch Bar.
2. Touch [Edit/Add to Route].
3. Touch a destination or waypoint that is already set.

3. Navigation

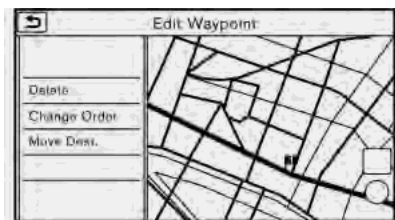

4. Touch the item you would like to set.

Available settings

- [Delete]:
A selected destination or waypoint that has already been set can be deleted.
 - [Change Order]:
The order of a destination and waypoints that are already set can be changed.
 - [Move Dest.]:
The location of the destination or waypoint can be adjusted by moving the cross pointer across the map on the touch screen display.
5. Touch [Calculate] to apply the change.





INFO:

If the destination is deleted, the final waypoint of the route becomes the destination.

Changing route calculation conditions

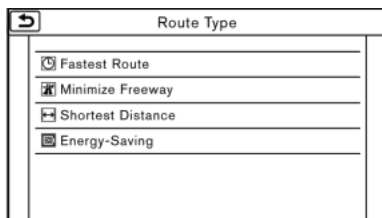
Each section of the route between waypoints can have different route calculation conditions.



1. Touch [Navi] on the Launch Bar.
2. Touch [Edit/Add to Route].
3. Touch the route condition shown on the preferred section of the route to the destination or waypoint.
4. Touch the preferred condition.
 "Route Settings" (page 3-47)
5. The conditions are changed and the display returns to the edit route screen.

6. Touch [Calculate] to apply the change.



INFO:

- The recalculated route may not be the shortest route because the system prioritizes roads that are easy to drive on for safety reasons.

Changing order of destination and waypoints

The order of a destination and waypoints that are already set can be changed.

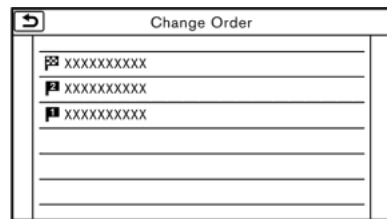

1. Touch [Navi] on the Launch Bar.
2. Touch [Edit/Add to Route].
3. Touch a destination or waypoint that is already set.
4. Touch [Change Order].
5. Touch a preferred destination or waypoint to replace the previously selected destination or waypoint.

6. Touch [Calculate] to apply the change.

RECALCULATING ROUTE

A route can be manually searched again after changing the search conditions, etc.

1. Touch [Navi] on the Launch Bar.
2. Touch [Recalculate]. A message is displayed and the route is recalculated.
3. Touch [Start] or conduct other operations as necessary.
 - ☞ "Options before starting the route guidance" (page 3-29)

INFO:

- When a waypoint has been set on the route, the system will search for only one route, even if route recalculation is performed.
- When the vehicle deviates from the suggested route, the route from the current location to the destination is automatically searched again by the Auto Reroute function.
 - ☞ "Route Settings" (page 3-47)

SEARCHING FOR DETOUR ROUTE USING TRAFFIC INFORMATION

When a serious traffic event occurs on the route, or if the system finds a faster route, a detour alert will display automatically. If the automatic alert is not noticed, a detour can also be searched for manually.

1. Touch [Navi] on the Launch Bar.
2. Touch [Traffic Detour].

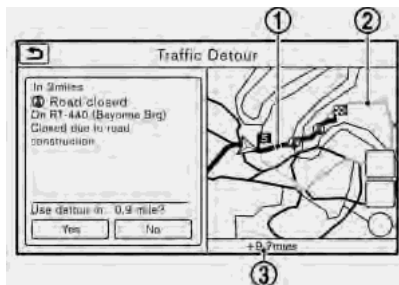

3. When the detour search is successful, detailed information about the detour route and the comparison screen of the two routes are displayed.
 - ① Original route (blue)
 - ② Detour route (purple)
 - ③ The change of distance and estimated travel time to destination when the detour route is taken.

4. To accept the suggested detour route, touch [Yes].

INFO:

- Without a subscription to SiriusXM Traffic, it will not be possible to receive traffic detour information or apply settings for functions related to traffic information. A message appears when a related menu item is selected.
 - ☞ "Notes on SiriusXM Traffic information" (page 6-8)
- If no route is set, or [Use Real Time Traffic Information] is turned off, this function cannot be operated.
 - ☞ "Route Settings" (page 3-47)
- If a detour route is not selected and no further action is performed, the detour route will be automatically canceled.
- The detour suggestion can be retrieved even after the message disappears by manually selecting [Traffic Detour]. The system will then search for the detour again and will suggest a detour if one is available at that time.

3. Navigation

Automatic detour guidance

When [Auto Reroute] and [Use Real Time Traffic Information] are turned on in the detailed route settings, a message will be displayed automatically when the system finds a detour.

 "Route Settings" (page 3-47)

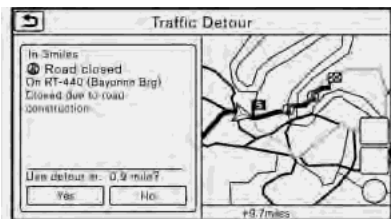

To accept the suggested detour route, touch [Yes].

INFO:

- If no operation is performed for 1 minute after the message is displayed, the message disappears. The detour will not be accepted, and the current suggested route will remain unchanged.
- When [Traffic Announcements] is turned on in the guidance settings, the system will announce voice guidance at the same time the message

appears on the screen.

 "Guidance settings" (page 3-45)

SETTING DETOUR ROUTE

To detour from the suggested route, a route detouring for a specified distance can be calculated.

1. Touch [Navi] on the Launch Bar.
2. Touch [Detour].
3. Touch a detour distance select from 1/2 mile (1 km), 1 mile (2 km), 3 miles (5 km) or 5 miles (10 km). After calculating the detour, the system displays the detour route on the map.

INFO:

- When the vehicle has deviated from the suggested route, [Detour] cannot be selected.
- If the system cannot calculate a detour with the specified conditions the previous suggested route is displayed.
- If the vehicle is traveling very fast, the detour route may start from a location that the vehicle has already passed.



ROUTE GUIDANCE SETTINGS

The route search conditions and route guidance can be set.

Guidance settings

Various guidance information can be set to be played during route guidance and the route and/or voice guidance can be activated or deactivated.

1. Touch [Settings] on the Launch Bar.
2. Touch [Navigation] and touch [Guidance Settings].
3. Touch an item you would like to set.

Setting item		Action
[Guidance Volume]		Adjusts the volume level of voice guidance.
[Guidance Voice]		Activates or deactivates voice guidance.
[Traffic Announcement]		Activates/deactivates the traffic announcement. When this item is activated, the system provides an announcement of a traffic information event on the route. The indicator illuminates if traffic announcement is activated.
[Intersection Guidance Settings]	[Tones Only]	When this item is turned on, a tone will sound at the timing of [At Turning Point], [Near Guidance] and [Basic Guidance].
	[1 Voice Guide]	When this item is turned on, a tone will sound at the timing of [At Turning Point] and [Near Guidance], and the voice guidance will be announced at the timing of [Basic Guidance].
	[2 Voice Guide]	When this item is turned on, a tone will sound at the timing of [At Turning Point], and the voice guidance will be announced at the timing of [Near Guidance] and [Basic Guidance].
	[3 Voice Guide]	When this item is turned on, a tone will sound at the timing of [At Turning Point], and the voice guidance will be announced at the timing of [Near Guidance], [Basic Guidance] and [Far Guidance].
[Estimated Time]	[Destination]	Displays  and the travel time to the destination on the map screen.
	[Waypoint]	Displays  and the travel time to the waypoint on the map screen.

3. Navigation

 **INFO:**

- The guidance volume can also be adjusted by turning **<VOL/  >** or pushing **<+>/<->** on the steering wheel while voice guidance is being announced.
- A SiriusXM Traffic subscription is necessary to use Traffic Announcement function.

Route Settings

It is possible to set the conditions of the route search.

1. Touch [Settings] on the Launch Bar.
2. Touch [Navigation] and touch [Route Settings].
3. Touch the item you would like to set.

Setting Item		Action	
[Basic Route Type]	[Energy-Saving]	Prioritizes the route with the lowest energy consumption.	
	[Fastest Route]	Prioritizes the use of freeways.	
	[Minimize Freeway]	Minimizes the use of freeways.	
	[Shortest Distance]	Prioritizes the shortest route. The recalculated route may not be the shortest route because the system prioritizes roads that are easy to drive on for safety reasons.	
[Other Routing Choices]	[Minimize Toll Roads]	Minimizes the use of toll roads.	
	[Time Restricted Rd]	[Use Restriction Info]	Calculates route taking time restriction information into consideration.
		[Do Not Use Restriction Info]	Calculates route without taking time restriction information into consideration.
		[Avoid]	Calculates route avoiding the use of time restricted roads.
	[Use Real Time Traffic Information]	Uses the latest traffic information received via the SiriusXM Traffic broadcast.  "Searching for detour route using traffic information" (page 3-43)	
	[Use Avoid Area Settings]	Enables the avoid area setting.	
[Use Ferries]	Includes the use of ferries.		

3. Navigation

	[Use Learned Routes]	Uses the roads that are most frequently traveled with the help of self-learning technology.
	[Use HOV Lanes]	Uses the HOV lanes.
	[Auto Reroute]	If the vehicle deviates from the suggested route, the system automatically recalculates a route that leads the vehicle to the suggested route.



INFO:

- If the vehicle greatly deviates from the suggested route, the system calculates a new route.
- Traffic jam information displayed on the map screen is not statistical traffic information.
- If [Do Not Use Restriction Info] is selected for [Time Restricted Rd] setting, the system calculates a route without any consideration of the regulations concerning the time or day of the week. Therefore, the suggested route may include a road subject to traffic regulations concerning the time or day of the week. When driving along the route, always follow all traffic regulations regardless of whether [Time Restricted Rd] is set to be considered or not.
- Even when [Use Real Time Traffic Information] is turned on, if traffic information has not been provided for the area, a detour may not always be indicated in a location where a traffic jam occurs.
- The system calculates to reduce the time required for the entire route from the start to the destination. If there are no appropriate routes, the system may lead to a route where a traffic jam occurs instead of leading to a detour.
- The system may not lead to a detour if traffic closure or a traffic jam occurs far from the present location.

VIEWING TRAFFIC INFORMATION

SiriusXM Traffic information is a subscription service offered by SiriusXM Satellite Radio.

This service provides real-time information regarding traffic flow, accidents, road construction and other incidents, where available.

SiriusXM Traffic combines information from commercial and public traffic data providers including government departments of transportation, police, emergency services, road sensors, cameras and aircraft reports. The traffic information is broadcast to the vehicle by the SiriusXM satellites. Available traffic information on the route the driver selected is shown on the navigation screen so traffic conditions between you and the destination are known. Three types of real-time traffic information for major roadways are shown on the navigation system:

- * Unscheduled traffic data for example, accidents and disabled vehicles.
- * Scheduled traffic data, for example road construction and road closures.
- * Traffic flow information (rate of speed data).



WARNING

SiriusXM Traffic information is not a substitute for attentive driving. Traffic conditions change constantly and emergency situations can arise without warning. Relying only on SiriusXM Traffic information may lead to a collision and could result in serious personal injury.



NOTE:

- **Flow information is provided only for roads equipped with traffic sensors and is not available in all markets covered by the service. Flow data may not be available on portions of a road that is under construction.**
- **A SiriusXM Traffic subscription is necessary to view Traffic Info.**
 **"SiriusXM Travel Link" (page 6-7)**

VIEWING AVAILABLE TRAFFIC INFORMATION

Viewing traffic events from list

1. Touch [Info] on the Launch Bar.
2. Touch [SXM Traffic]. A list of available types of information are displayed.

Available items	Function
[Info on Route]	Displays a list of traffic information found on the route from the current vehicle location to the destination. Available only when a route is set.
[Nearby Traffic Info]	Displays a list of available traffic information around the current vehicle location.

3. Touch the preferred information. A list of available events are displayed.

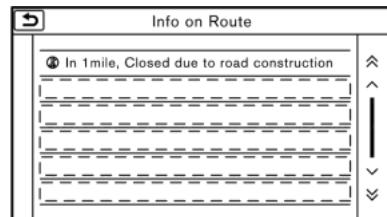

3. Navigation

4. Touch a preferred events from the list to check the detailed information and the map.

Displaying urgent traffic information

When an urgent event is found around the current vehicle location, a message pops up automatically on the touch screen display with a voice announcement.

The message includes the icon, event type, event information and the direct distance from the current location to the event.



INFO:

- Urgent traffic information is displayed regardless of whether [Use Traffic Info] function is on or off.
☞ "Traffic information setting" (page 3-51)
- When there are multiple urgent events, the event with the shortest direct distance from the current location is displayed.
- If the urgent event is on the recommended route, and if a detour is found, the detour route notification screen is displayed when the vehicle ap-

proaches the detour point.

Traffic information on map

With a subscription to SiriusXM Traffic service, traffic information is displayed on both 2D map and Birdview™ map screen.

☞ "Notes on SiriusXM Traffic information" (page 6-8)

Screen information

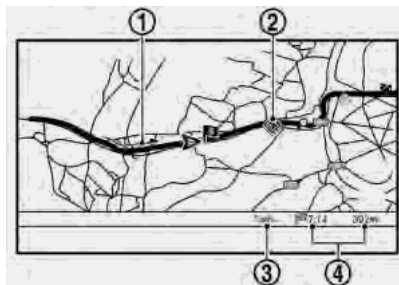

- ① Road conditions:
Free Flow: Green arrow
Moderate traffic: Yellow arrow
Heavy traffic: Red arrow
Section affected by serious traffic event: Purple arrow
- ② Traffic information icon:
If a route is not already set, all of the traffic information icons on the map screen are displayed in color. When a route is already set, the icons on the route are displayed in color, and the icons outside the route are displayed in gray.
 : Accident
 : Closed road
 : Information
 : Road work
 : Slippery road
 : Weather
 : Incident
- ③ Traffic indicator:
Displays the reception condition of traffic information transmitted from the provider.
When reception condition of traffic information transmitted from the provider is not detected, the traffic indicator will be "grayed-out".

- ④ Remaining distance and estimated time to the destination calculated with consideration of traffic information on route.



INFO:

Traffic icons are displayed in the scale level of 1/64 miles (25 m) - 5 miles (10 km) range. Some traffic icons are displayed only on the map at higher detail levels.

TRAFFIC INFORMATION SETTING

Settings for the traffic information related functions can be changed.

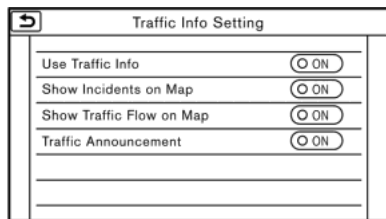

1. Touch [Settings] on the Launch Bar.
2. Touch [Navigation].
3. Touch [Traffic Info Setting].
4. Touch the preferred setting. The indicator for the selected setting illuminates.

Available setting items

- [Use Traffic Info]: Enables all traffic information related functions.
- [Show Incidents on Map]: Displays the traffic incidents (e.g., accident) on the map screen.
- [Show Traffic Flow on Map]: Displays the traffic flow with an arrow on the map screen.
- [Traffic Announcement]: Announces the traffic information event on the route.



INFO:

- Even when [Show Traffic Flow on Map] and [Show Incidents on Map] are set to off, the list display of [Info on Route] and [Nearby Traffic Info] will not be affected.
 "Viewing traffic events from list" (page 3-49)
- Even when [Traffic Announcement] is set to off, the route guidance will not be affected. Also, the announcement of emergency information and weather information will not be turned off.



Voice command

1. Push <  > located on the steering wheel.
2. After the tone sounds, speak a command.

Use the following voice command to turn the traffic information system on/off:

"Traffic Information"

3. Navigation

STORING A LOCATION/ROUTE

STORING LOCATION

Often visited locations can be stored in the Stored Locations. The stored addresses can be easily retrieved to set them as a destination or waypoint. The Stored Locations can store up to 200 locations.

Storing home location

A home location can be stored in the system.

This operation is not available when a destination is set for route guidance.



1. Touch [Navi] on the Launch Bar.
2. Touch [Home].
3. If a home location is not registered, the system asks if you wish to store it. Touch [Yes] to continue with the storing operation.

4. Set the Home location using the same procedure as setting a destination.
☞ "Setting destination" (page 3-16)
5. The selected location is displayed on the map screen as a home icon. Edit the contents of the stored item as necessary and touch [OK].
☞ "Editing stored home and location" (page 3-55)

Other Settings

1. Touch [Settings] on the Launch Bar.
2. Touch [Navigation] and touch [Address Book].
3. Touch [Home Location (None)].
4. Touch an appropriate method to set a location. Refer to the search methods used for destination setting.
☞ "Setting destination" (page 3-16)
When stored, the location is displayed at the center of the map on the touch screen display.
5. Edit the contents of the stored item as necessary and touch [OK].
☞ "Editing stored home and location" (page 3-55)

Storing location by searching

It is possible to store a location by searching in various ways.

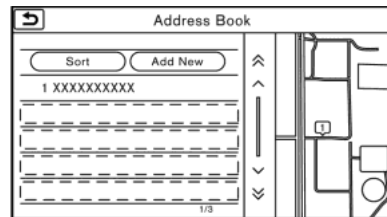

1. Touch [Settings] on the Launch Bar.
2. Touch [Navigation].
3. Touch [Address Book].
4. Touch [Stored Locations].
5. Touch [Add New].
6. Touch a method to set a location. Refer to the search methods used for destination setting.
☞ "Setting destination" (page 3-16)
7. A message is displayed, and the address of the location is stored in the Address Book.
8. Adjust and edit the contents of the stored item as necessary. Touch [OK] to confirm.
☞ "Editing stored home and location" (page 3-55)

INFO:

- When the location is stored in the Stored Locations, [Address Book] can be used to search for the location.
 "Searching from address book" (page 3-24)
- When 200 locations are already stored, a new location cannot be stored until a currently stored location is deleted.

Storing location by moving map

1. Move to the preferred location on the map and touch  on the touch screen display.

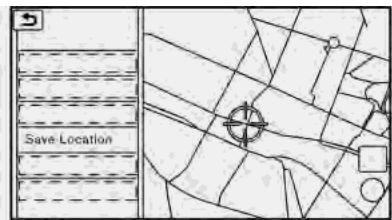

2. Touch [Save Location]. A message is displayed.
3. The icon representing the stored location is displayed on the map. Push **<MAP>** to return to the current location map screen.

STORING ROUTE

A maximum of 5 calculated routes can be stored. Stored routes can be easily retrieved and set as the suggested route.

If any waypoints are not set on the route, the route cannot be stored.

1. Touch [Navi] on the Launch Bar.
2. Touch [Route Info].
3. Touch [Store Route]. A confirmation message is displayed. Select [Yes] to store the current route.

Other settings

A route can also be stored using the following procedure.

1. Touch [Settings] on the Launch Bar.
2. Touch [Navigation].
3. Touch [Address Book].
4. Touch [Stored Routes].
5. Touch [Store Current Route]. A confirmation message is displayed.
6. Confirm the contents of the message and touch [Yes]. The current route is stored.

INFO:

- At least 1 waypoint must be set for the route to be stored.
- A stored route includes only locations (destination and waypoints) and route calculation conditions, not the route itself.
- The route is stored in the first available position number in the store current route list.
- When 5 routes are already stored in the address book, a new route cannot be stored until a route is deleted.
 "Deleting stored item" (page 3-57)

STORING AVOID AREA

An Avoid Area can be stored. The Avoid Area is an area that can be excluded from a route, such as a road that is always congested. Once Avoid Areas are stored, the system avoids those areas when calculating a route. Up to 10 Avoid Areas can be stored.

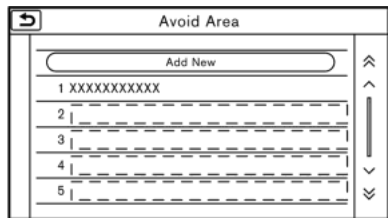

1. Touch [Settings] on the Launch Bar.
2. Touch [Navigation].
3. Touch [Address Book].
4. Touch [Avoid Area].

3. Navigation



EDITING STORED INFORMATION

Items stored in the system can be edited.

5. Touch [Add New].
Touch an appropriate method to search for a location.
 "Setting destination" (page 3-16)
6. Adjust the information of the Avoid Area as necessary.
 "Editing avoid area" (page 3-57)
7. Touch [OK] to store the avoid area information.





INFO:

- A maximum of 10 Avoid Areas can be stored. When 10 Avoid Areas are already stored, a new Avoid Area cannot be stored until a currently stored Avoid Area is deleted.
 "Deleting stored item" (page 3-57)

Editing stored home and location

1. Touch [Settings] on the Launch Bar.
2. Touch [Navigation] and touch [Address Book].

Setting item			Action
[Home Location]*	[Edit]	[Show Icon on Map]	Displays the home icon on the map.
		[Icon]	Selects a home icon of a preferred design.
		[Sound]	Sets the type of the alarm that sounds when the vehicle approaches home.
		[Direction]	Sets the alarm to sound when approaching from a specific direction.
		[Distance]	Sets the alarm to sound when reaching a specific distance to home.
		[Phone No.]	Stores the home telephone number.
	[Move Location]	Adjusts the stored home location.	
	[Delete]	Deletes the stored home location.	
[OK]	Confirms and saves the edited home information.		
[Stored Locations]	[Sort]	[Sorted By Number]	Sorts the stored locations.  "Searching from address book" (page 3-24)
		[Sorted By Name]	
		[Sorted By Icon]	
		[Sorted By Group]	
	[Add New]	Adds a new location.  "Storing location by searching" (page 3-52)	
Stored Location List	[Edit]	[Show Icon on Map]	Displays the icon on the map.

3. Navigation

			[Name]	Registers a name of the entry.
			[Voicetag]	Registers a voicetag for the entry which allows the entry to be used with the voice recognition system.
		[Charging Sta. Att.]	[Quick Charge Station]	The location is registered as a charging station with quick charge equipment and can be included in the charging station search.
			[Normal Charge Station]	The location is registered as a s charging station with normal charge equipment and can be included in the charging station search.
			[Not a Charge Station]	The location is registered as a location that is not a charging station.
			[Icon]	Selects an icon for the entry.
			[Sound]	Sets the type of the alarm that sounds when the vehicle approaches the location.
			[Direction]	Sets the alarm to sound when approaching from a specific direction.
			[Distance]	Sets the alarm to sound when reaching a specific distance to the location.
			[Phone No.]	Registers a phone number of the location.
			[Group]	Registers a group of the entry.
			[Entry Numbers]	Registers an entry number for the location.
		[Move Location]		Adjusts the stored location information.
		[Delete]		Deletes the stored location information.

		[OK]	Confirms and saves the edited stored location information.
--	--	------	--

*: When home location has not been stored, [Home Location (None)] is displayed and a home location can be stored from the menu.

Editing stored route

1. Touch [Settings] on the Launch Bar.
2. Touch [Navigation] and touch [Address Book].
3. Touch [Stored Routes].
4. Touch the preferred stored route from the list.

Setting item	Action
[Rename]	Changes the stored route name.
[Replace]	Overwrites the stored tracked route to the current tracked route.
[Delete]	Deletes the stored route.
[OK]	Applies the edited settings.

Editing avoid area

1. Touch [Settings] on the Launch Bar and touch [Navigation].

2. Touch [Address Book] and then touch [Avoid Area].
3. Touch a preferred Avoid Area from the list. Avoid Area editing screen will be displayed.

Setting item	Action
[Rename]	Changes the name of an Avoid Area.
[Move Location]	Display the Avoid Area on the touch screen display, and adjusts the location of the Avoid Area.
[Resize Area]	Adjusts the range of the Avoid Area.
[FWY]	Sets the route to include or not include freeways. On the map, the Avoid Area will be displayed in green if it includes a freeway or in blue if it does not include a freeway.
[Delete]	Delete an Avoid Area.
[OK]	Applies the edited setting.

DELETING STORED ITEM

The locations and routes in the Address Book can be deleted. Two deletion methods are available: deleting an individual item and deleting all stored items.



INFO:

- Deleted items cannot be restored. Before deleting an item, always make sure that the item is no longer needed.

3. Navigation

Deleting stored item individually

1. Touch [Settings] on the Launch Bar.
2. Touch [Navigation] and touch [Address Book].
3. Touch [Delete Stored Items].

Select the preferred item and touch [Yes] to complete the deleting operation.

Step 1	Step2	Action
[Delete Home Location]		Deletes home location.
[Delete Address Book]	[Delete All]	Deletes all stored locations.
	[Delete One]	Deletes a selected stored location.
[Delete Stored Routes]	[Delete All]	Deletes all stored routes.
	[Delete One]	Deletes selected stored routes.
[Delete Avoid Areas]	[Delete All]	Deletes all Avoid Areas.
	[Delete One]	Deletes a selected Avoid Area.
[Delete Previous Destinations]	[Delete All Previous Destinations]	Deletes all of the previous destinations.
	[Delete Previous Destination]	Deletes a selected previous destination.
	[Delete Previous Start Point]	Deletes a previous start point.
[Delete Learned Routes]		Deletes all system learned routes.

Deleting individual item on map

1. Align the cross pointer over the preferred stored location for deletion by moving on the map, and then touch

[Map Menu].

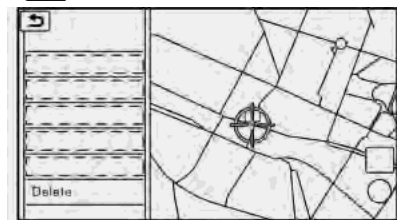

2. Touch [Delete].
3. A confirmation message is displayed. Confirm the contents of the message and touch [Yes].

The stored item is deleted from the Address Book.

TRANSFERRING INFORMATION TO/FROM ADDRESS BOOK

The information of the stored home and addresses can be exported and imported using a USB memory device.

- 🔌 "USB (Universal Serial Bus) Connection Port and AUX (auxiliary) input jack" (page 1-5)

 **INFO:**

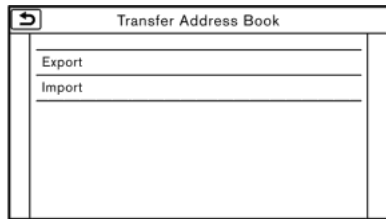

1. Touch [Settings] on the Launch Bar.
2. Touch [Navigation].
3. Touch [Address Book].
4. Touch [Transfer Address Book].
5. Touch [Export] or [Import].
6. Touch [Home Location] or [Stored Locations].
7. Touch [Download].

 **NOTE:**

Do not remove the USB memory device until the system completely imports or exports the data.

 **INFO:**

- If the USB memory device already has the data for a stored address, a confirmation message will be displayed. Once overwritten, the original data cannot be recovered.
- A USB memory device can be used to transfer data but it is not possible to edit the data using a personal computer, etc.

3. Navigation

NAVIGATION SETTINGS

The navigation system can be customized according to the user's preference.

1. Touch [Settings] on the Launch Bar.
2. Touch [Navigation].
3. Touch the item you would like to set.

Available items:

[Address Book]

Stores locations and routes. Stored items can be edited.

 "Editing stored information" (page 3-54)

[Map View]

Sets the display method and direction of the map.

 "Map view settings" (page 3-11)

[Map Icons]

Sets the map icons to appear on the map.

 "Displaying map icons" (page 3-14)

[Guidance Settings]

Sets the various functions for route guidance.

 "Guidance settings" (page 3-45)

[Route Settings]

Changes the routing preferences.

 "Route Settings" (page 3-47)

[Traffic Info Setting]

Sets the various functions of the SiriusXM Traffic information system.

 "Traffic information setting" (page 3-51)

[Speed Limit Indication on Map]

Turns on/off the speed limit display function. When this item is turned on, speed limit indicator will appear on the map screen when

available.

[Others]

Setting item		Action
[Audio Display on Map]		Turns the audio information display on the map screen on/off.
[Map Scrolling Information]	[Address Book Icons]	Information about the location, on which the center of the cross pointer is placed by scrolling on the map, can be set to be displayed.  "Displaying map scrolling information" (page 3-14)
	[Destination/Waypoint Icons]	
	[Show pop-up for POIs]	
	[Latitude/Longitude Info]	
[Customize Nearby POIs]	Item 1 - Item 4	Customizes the nearby categories to show the categories that you frequently use.
	[Reset]	Resets the nearby categories to default.
[Keyboard Type]	[QWERTY]	The keyboard layout of the character input screens can be selected.
	[ABC]	
[Tracking Dots Displayed on Map]	[Show Tracking Dots on Map]	Turns the route tracking dots display on/off.
	[Dist. Between Tracking Dots]	Select tracking dot interval.
	[Delete Track to Current Location]	Deletes the route tracking dots up to the current location.
[Adjust Current Location]		If the vehicle icon indicating the current vehicle location is not in the correct position, the location of the vehicle icon on the map screen can be adjusted.

3. Navigation

[Delete Stored Items]

Deletes a stored location or route.

 "Deleting stored item individually" (page 3-58)

[Delete Previous Destinations]

Deletes all or one of the previous destinations or a previous start point.

 "Deleting stored item individually" (page 3-58)

[Reset All Navigation Settings to Default]

This resets various settings (display, volume level, etc.) to the default settings.

4 Audio system

Audio operation precautions	4-2	Audio operations	4-9
Radio	4-2	Audio main operation	4-9
USB (Universal Serial Bus) connection port.....	4-3	Radio	4-10
Compressed Audio Files (MP3/WMA/AAC).....	4-6	USB memory device player	4-15
Bluetooth® streaming audio	4-7	iPod® player	4-18
Names and functions of audio		Bluetooth® audio	4-22
control buttons	4-8	Auxiliary (AUX) devices	4-25
Audio main buttons	4-8	Audio settings.....	4-26
Steering wheel mounted audio		Audio adjustments when map, audio or	
control buttons.....	4-9	home menu is displayed.....	4-26

4. Audio system

AUDIO OPERATION PRECAUTIONS

RADIO

The radio can be turned on when the power switch is in the ACC or ON position. To listen to the radio for extended period of time with the EV system not running, the power switch should be placed in the ON position.

Radio reception is affected by station signal strength, distance from radio transmitter, buildings, bridges, mountains and other external influences. Intermittent changes in reception quality normally are caused by these external influences.

Using a cellular phone in or near the vehicle may influence radio reception quality.

Radio reception

Your radio system is equipped with state-of-the-art electronic circuits to enhance radio reception. These circuits are designed to extend reception range, and to enhance the quality of that reception.

However there are some general characteristics of both FM and AM radio signals that can affect radio reception quality in a moving vehicle, even when the finest

equipment is used. These characteristics are completely normal in a given reception area, and do not indicate any malfunction in your radio system.

Reception conditions will constantly change because of vehicle movement. Buildings, terrain, signal distance and interference from other vehicles can work against ideal reception. Described below are some of the factors that can affect your radio reception.

Some cellular phones or other devices may cause interference or a buzzing noise to come from the audio system speakers. Storing the device in a different location may reduce or eliminate the noise.

FM radio reception

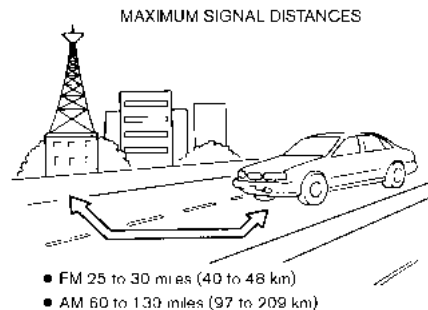

Range: the FM range is normally limited to 25 to 30 miles (40 to 48 km), with monaural (single station) FM having slightly more range than stereo FM. External influences may sometimes interfere with FM station reception even if the FM station is within 25 miles (40 km). The strength of the FM signal is directly related to the distance between the transmitter and receiver. FM signals follow a line-of-sight path, exhibiting many of the same characteristics as light. For example they will reflect off objects.

Fade and drift: As your vehicle moves away from a station transmitter, the

signals will tend to fade and/or drift.

Static and flutter: During signal interference from buildings, large hills or due to antenna position, usually in conjunction with increased distance from the station transmitter, static or flutter can be heard. This can be reduced by lowering the treble setting to reduce the treble response.

Multipath reception: Because of the reflective characteristics of FM signals, direct and reflected signals reach the receiver at the same time. The signals may cancel each other, resulting in momentary flutter or loss of sound.

AM radio reception

AM signals, because of their low frequency, can bend around objects and skip along the ground. In addition, the signals can bounce off the ionosphere and be bent back to earth. Because of these characteristics, AM signals are also subject to interference as they travel from transmitter to receiver.

Fading: Occurs while the vehicle is passing through freeway underpasses or in areas with many tall buildings. It can also occur for several seconds during ionospheric turbulence even in areas where no obstacles exist.

Static: Caused by thunderstorms, electri-

cal power lines, electric signs and even traffic lights.

HD Radio™ Technology reception (for U.S.)

HD Radio Technology reception needs to be activated to receive HD Radio broadcasts.

 "Radio Menu" (page 4-12)

This enables you to receive radio broadcasts digitally (where available), providing a better quality sound with clear reception. When this feature is not activated or HD Radio broadcasts are not available, you will receive analog radio (AM/FM) broadcasts.

Satellite radio reception

When the satellite radio is used for the first time or the battery has been replaced, the satellite radio may not work properly. This is not a malfunction. Wait more than 10 minutes with the satellite radio ON and the vehicle outside of any metal or large building for the satellite radio to receive all of the necessary data.

SiriusXM services require a subscription after trial period and are sold separately or as a package. The satellite service is available only in the 48 contiguous USA and DC. SiriusXM satellite service is also

available in Canada; see www.siriusxm.ca. The satellite radio performance may be affected if cargo carried on the roof blocks the satellite radio signal.

If possible, do not put cargo near the satellite antenna.

A buildup of ice on the satellite radio antenna can affect satellite radio performance. Remove the ice to restore satellite radio reception.

USB (Universal Serial Bus) CONNECTION PORT



WARNING

Do not connect, disconnect or operate the USB device while driving. Doing so can be a distraction. If distracted you could lose control of your vehicle and cause an accident or serious injury.



CAUTION

- **Do not force the USB device into the USB connection port. Inserting the USB device tilted or up-side-down into the port may damage the port. Make sure that the USB device is connected correctly into the USB connection port.**

4. Audio system

- **Do not leave the USB cable in a place where it can be pulled unintentionally. Pulling the cable may damage the port.**

The vehicle is not equipped with a USB device. USB devices should be purchased separately as necessary.

This system cannot be used to format USB devices. To format a USB device, use a personal computer.

In some states/areas, the USB device for the front seats plays only sound without images for regulatory reasons, even when the vehicle is parked.

This system supports various USB memory devices, USB hard drives and iPod® players. Some USB devices may not be supported by this system.

- Partitioned USB devices may not be played correctly.
- Some characters used in other languages (Chinese, Japanese, etc.) are not displayed properly on the display. Using English language characters with a USB device is recommended.

General notes for USB use:

Refer to your device manufacturer's owner information regarding the proper care

of the device.

Notes for iPod® use:

- Improperly plugging in the iPod® may cause a checkmark to be displayed on and off (flickering). Always make sure that the iPod® is connected properly.
- Audiobooks may not play in the same order as they appear on an iPod®.

Specification chart for USB

Supported media	USB2.0
Supported file systems	FAT12, FAT16, FAT32
Folder levels	Folder levels: 8, Files via folder: 255, Folders: 512 (including root folder), Files: 8000
Tag information (Song title, Artist name and Album name)	ID3 tag VER1.0, VER1.1, VER2.2, VER2.3, VER2.4 (MP3 only)
	WMA tag (WMA only)
	AAC tag (AAC only)

Format			Sampling frequency	Supported bitrate
MP3 *1	MPEG1	Layer-3	32, 44.1, 48 kHz	32-320 kbps
	MPEG2		16, 22.05, 24 kHz	8-160 kbps
WMA *2			8, 11.025, 16, 22.05, 32, 44.1, 48 kHz	12-192 kbps
AAC (MPEG4) *3 (Extension "m4a" only)			11.025, 16, 22.05, 32, 44.1, 48 kHz	8-320 kbps

*1 MPEG2.5 is not supported.

*2 WMA7, WMA8, WMA9, WMA9.1, WMA9.2 are supported. (WMA9 Professional, Lossless, Voice are not supported.)

*3 Only AAC files encoded by iTunes® are supported. HE-AAC (High-Efficiency) is not supported.

4. Audio system

COMPRESSED AUDIO FILES (MP3/WMA/AAC)

Explanation of terms

- **MP3** — MP3 is short for Moving Pictures Experts Group Audio Layer 3. MP3 is the most well-known compressed digital audio file format. This format allows for near “CD quality” sound, but at a fraction of the size of normal audio files. MP3 conversion of an audio track can reduce the file size by approximately a 10:1 ratio (Sampling: 44.1 kHz, Bit rate: 128 kbps) with virtually no perceptible loss in quality. The compression reduces certain parts of sound that seem inaudible to most people.
- **WMA** — Windows Media Audio (WMA) is a compressed audio format created by Microsoft as an alternative to MP3. The WMA codec offers greater file compression than the MP3 codec, enabling storage of more digital audio tracks in the same amount of space when compared to MP3s at the same level of quality.
- **Bit rate** — Bit rate denotes the number of bits per second used by a digital music file. The size and quality of a compressed digital audio file is deter-

mined by the bit rate used when encoding the file.

- **Sampling frequency** — Sampling frequency is the rate at which the samples of a signal are converted from analog to digital (A/D conversion) per second.
- **Multisession** — Multisession is one of the methods for writing data to media. Writing data once to the media is called a single session, and writing more than once is called a multisession.
- **ID3/WMA tag** — The ID3/WMA tag is the part of the encoded MP3 or WMA file that contains information about the digital music file such as song title, artist, album title, encoding bit rate, track time duration, etc. ID3 tag information is displayed on the Album/Artist/Track title line on the display.
- **AAC** — Advanced Audio Coding (AAC) is a compressed audio format. AAC offers greater file compression than MP3 and enables music file creation and storage at the same quality as MP3.

Playback order

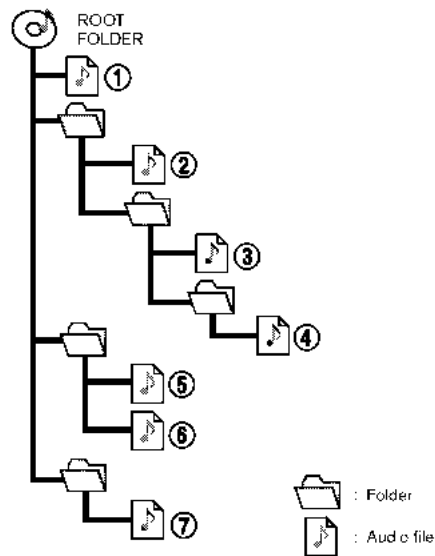

- The folder names of folders not containing compressed audio files are not shown on the display.
- The playback order is the order in which the files were written by the

writing software, so the files might not play in the desired order.

- Music playback order of compressed audio files is as illustrated.

BLUETOOTH® STREAMING AUDIO

- Some Bluetooth® audio devices may not be recognized by the in-vehicle audio system.
- It is necessary to set up the wireless connection between a compatible Bluetooth® audio device and the in-vehicle Bluetooth® module before using the Bluetooth® streaming audio.
- The Bluetooth® streaming audio may stop playing when
 - receiving a hands-free call.
 - checking the connection to the hands-free phone.
 - connecting the hands-free phone or the audio device.
 - downloading the phonebook memory from the connected cellular phone.
- Do not place a Bluetooth® audio device in an area surrounded by metal or far away from the in-vehicle Bluetooth® module to prevent tone quality degradation and wireless connection disruption.
- While an audio device is connected through a Bluetooth® wireless connection, the battery of the device may discharge quicker than usual.
- This system supports the Bluetooth® Advanced Audio Distribution Profile (A2DP) and Audio/Video Remote Control Profile (AVRCP).
- Wireless LAN (Wi-Fi) and the Bluetooth® functions share the same frequency band (2.4 GHz). Using the Bluetooth® and the wireless LAN functions at the same time may slow down or disconnect the communication and cause undesired noise. It is recommended that you turn off the wireless LAN (Wi-Fi) when using the Bluetooth® functions.

4. Audio system

NAMES AND FUNCTIONS OF AUDIO CONTROL BUTTONS

AUDIO MAIN BUTTONS



① **<AUDIO>**:

Push to display the audio screen.

Push again to display the audio source menu screen.

② **<VOL/ \updownarrow >**:

Push to turn the audio system on or off.

Turn to adjust the volume.

③ **< \ll / \lll / \gg / \ggg >**:

Selecting and fast-forwarding/re-winding tracks and radio station/channel seek tuning can be performed.

④ **<TUNE-SCROLL/SOUND>**:

Turn to manually tune AM/FM, to select SiriusXM categories and to select MP3/WMA/AAC folders. If no folders are found, tracks will be skipped.

Push to select the highlighted item when a menu screen is displayed. When this button is pushed when no item on the screen is highlighted, the audio settings can be changed.

 "Audio adjustments when map, audio or home menu is displayed" (page 4-26)

STEERING WHEEL MOUNTED AUDIO CONTROL BUTTONS

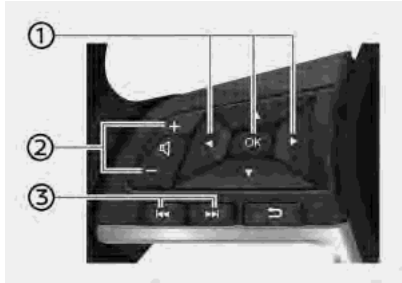

① < ◀ ▶ / < ▶ ▶ / < OK >:

Push < ◀ ▶ > / < ▶ ▶ > and switch the vehicle information display to audio mode.

Push < OK > until the preferred available audio source is selected.

② < + > / < - >:

Push < + > or < - > to adjust the volume.

③ < ◀◀ ▶▶ > / < ▶▶ ▶▶ >:

Pushing the switch when the audio system is turned on can operate the audio system such as changing tracks and radio preset stations or channels.

"Audio operations" (page 4-9)

AUDIO OPERATIONS

AUDIO MAIN OPERATION

Turning audio system on/off

The power switch must be pushed to the ACC or ON position to turn on the audio system. Push < VOL / ◂ > to turn on the last audio source that was playing immediately before the system was turned off. Pushing < AUDIO > or touching [Audio] on the Launch Bar will also turn on the audio system and the corresponding audio screen will be displayed for operation. To turn off the audio system, push < VOL / ◂ > again.

INFO:

Even when the audio system is turned off, operating the buttons/keys for audio may turn on the audio system.

Selecting audio source

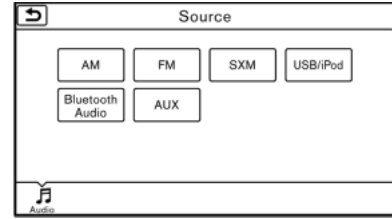

1. Push < AUDIO > or touch [Audio] on the Launch Bar when the audio screen is displayed.
2. Select an item from the audio source menu screens.

INFO:

- Touching [Source] on the upper left corner of the audio screen will also display the audio source menu screen.
- Pushing switches on the steering wheel can also be used to change audio sources.
 "Steering wheel mounted audio control buttons" (page 4-9)

4. Audio system

RADIO

How to view radio screen

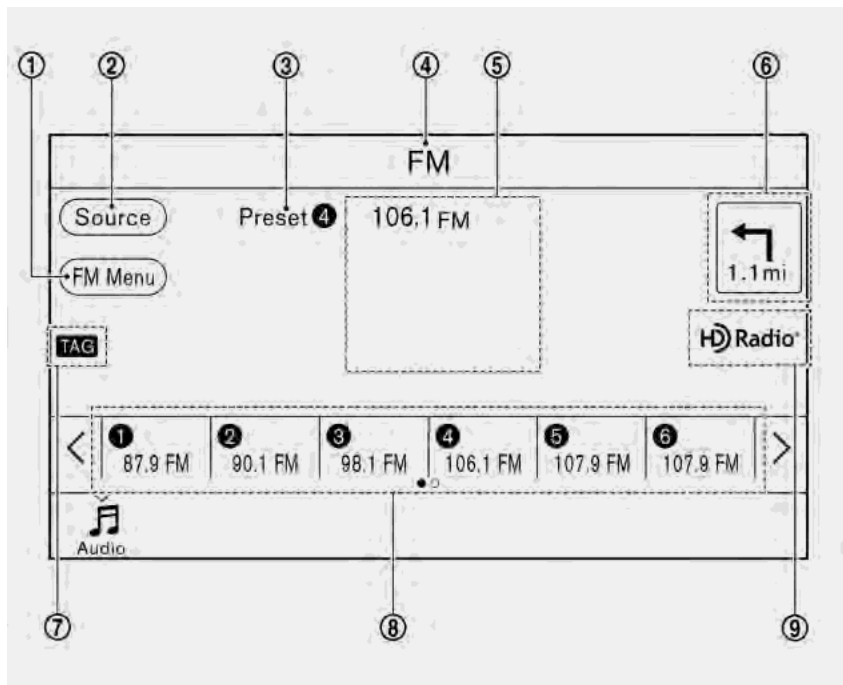

The radio screen can be viewed and operated on the touch screen display.

- ① [AM Menu]/[FM Menu]/[SXM Menu]:
Touch to display the radio menu screen.
☞ "Radio Menu" (page 4-12)
- ② [Source]:
Touch to display the audio source screen to select the other audio source.
☞ "Selecting audio source" (page 4-9)
- ③ Preset number:
A preset number is displayed if the current frequency is stored as a preset station or channel.
- ④ Audio source indicator:
Indicates the currently selected audio source.
- ⑤ Reception information display:
Reception information currently available such as frequency, station, or channel name, etc. are displayed.
- ⑥ Turn direction indicator:
When a route to the destination is set, turning direction and the distance to the next turn is displayed.

⑦ TAG indicator (for U.S.):

TAG indicator is displayed if the iTunes® Tagging information exists in the HD Radio broadcast signal.

 "Radio Menu" (page 4-12)

⑧ Preset list:

To listen to a preset station, touch the corresponding key in the preset list. Touch [<] or [>] to scroll the preset list. Touch and hold one of the keys in the preset list to store the station or channel currently tuned to.

 "Presetting" (page 4-11)

⑨ Mode indicator (for U.S.):

On AM and FM screens, HD Radio icon will appear when HD Radio mode setting is turned on.

 "Radio Menu" (page 4-12)

"Live" will appear when in ballgame mode during reception of the HD Radio broadcast.

INFO:

- An icon indicating the signal strength appears on the SXM screen.
- HD Radio (for U.S.) reception needs to be activated to receive HD Radio broadcasts. This enables you to receive radio broadcasts digitally (where

available), providing a better quality sound with clear reception. When this feature is not activated or HD Radio broadcasts are not available, you will receive analog radio (AM/FM) broadcasts.

 "Radio Menu" (page 4-12)

Radio operation

Radio activation and band selection:

To listen to the radio, turn on the audio system and select a preferred radio band by touching a preferred item on the audio source menu screen.

 "Selecting audio source" (page 4-9)

INFO:

When the stereo broadcast signal is weak, the radio will automatically change from stereo to monaural reception.

Tuning:

To tune to stations/channels manually, turn **<TUNE:SCROLL/SOUND>** until the preferred station/channel is selected.

For AM and FM, push and hold **<◀▶▶▶/<▶▶▶▶>** on the control panel until the preferred station is selected.

For SXM, push **<◀▶▶▶/<▶▶▶▶>** on the control panel or push and hold **<◀▶▶▶/<▶▶▶▶>** on the steering wheel until the preferred channel is selected.

Seek tuning (AM and FM):

Pushing **<◀▶▶▶/<▶▶▶▶>** on the control panel or pushing and holding **<◀▶▶▶/<▶▶▶▶>** on the steering wheel will seek tune the stations and stop at the frequency where a broadcast is detected. The stations will be skipped until the button is released.

Scan tuning:

To scan tune the stations/channels, touch [FM Menu], [AM Menu] or [SXM Menu] on the radio screen and then touch [SCAN]. The stations/channels will be tuned from low to high frequencies and stop at each broadcasting station/channel for several seconds. Touching [SCAN] again during this period of several seconds will stop scan tuning and the radio will remain tuned to that station/channel.



Presetting:

Up to 6 for AM, 12 for FM and 18 for SXM stations/channels can be registered in the preset list.

1. Select a radio band (AM, FM or SXM).

4. Audio system

2. Tune to the station/channel you wish to store in the preset list.
3. Touch and hold one of the preset numbers in the preset list.
4. The information such as frequency (AM/FM), channel number (SXM), etc. will be displayed on the preset list.

To select and listen to the preset stations/channels, push <  > / <  > on the steering wheel briefly or touch a preferred station/channel on the preset list on the radio screen.

Radio Menu

Touch [FM Menu], [AM Menu], and [SXM Menu] on the FM, AM or SXM screen to display the corresponding screen.

The following items are available.

[FM Menu]/[AM Menu]:

[Scan]	Touch to scan tune the stations.  "Radio operation" (page 4-11)
[Tag] (HD Radio broadcasts only)	Touch to register the tag information for iTunes® Tagging. If an iPod® is plugged in after the registration, the tag information can be stored in an iPod® and be used to purchase the songs via iTunes®.
[Station List]	Touch to display the available station list. Touch [Update Station List] to update the station list.
[HD Radio Mode] (HD Radio broadcasts only)	When this item is turned on, the analog and digital reception switches automatically. When this item is turned off, the reception is fixed in the analog mode.

[SXM Menu]:

[Scan]	Touch to scan tune the channels.  "Radio operation" (page 4-11)
[Tag]	Touch to register the tag information for iTunes® Tagging. If an iPod® is plugged in after the registration, the tag information can be stored in an iPod® and be used to purchase the songs via iTunes®.
[Replay]	Up to 30 minutes of the broadcast of the channel that has been tuned in to can be replayed. Touch to select from [▶], [⏏], [▶▶], [◀◀], [▶▶] and [◀◀].
[Favorite]	Touch to display a pop-up screen to register the content of an active channel. On the registration screen, touch [Artist] to save to a list of favorite artist. Touch [Song] to save to a list of favorite songs. Touch [Cancel] to close the registration screen.
[Categories/Genres]	Touch to display the category/genre list.
[Customize Channel List]	Touch to customize the channel list. Only the selected channels will be tuned in to when you seek or scan the channels. You can select each item or select [All Select]/[All Clear].
[Favorite Artists]	Touch to display a list of saved artists. Up to 8 artists can be stored. To turn on alerts for a favorite artist, select the artist and touch [Turn all alerts ON]. Touch [Delete All Favorites] to delete all the registered favorite artists.
[Favorite Songs]	Touch to display a list of saved songs. Up to 8 songs can be stored. To turn on alerts for a favorite song, select the song and touch [Turn all alerts ON]. Touch [Delete All Favorites] to delete all the registered favorite songs.
[Direct Tune]	Touch to display the keypad to enter the frequency and directly tune to the channel. Touch [Now Playing] to return to the SXM screen.
[Artist Alert History]	Touch to display the artist alert history.
[Song Alert History]	Touch to display the song alert history. Touch [Now Playing] to return to the SXM screen.

4. Audio system

[Alert Settings]	[Alerts for Artists]	Touch to turn on/off the alert notice.
	[Alerts for Songs]	Favorite artists and songs can be registered to receive an alert notice when a song of the registered conditions is on the radio. To tune to the respective channel, touch [Tune] on the alert screen. The alert can be ignored by touching [Cancel].
	[Alerts on non-Audio screens]	
[Channel Lock Settings]*	[Use Channel Lock]	Turn this item on to activate the channel lock function.
	[Passcode Change]	Touch to display the keyboard screen to change the passcode.
	[Lock Channel Settings]	Touch to display the Lock Channel setting screen. Touch and turn on the indicator of the channels on the list you wish to lock out.

*: The default passcode is "1234".



INFO:

- SiriusXM services require a subscription after trial period and are sold separately or as a package. The satellite service is available only in the 48 contiguous USA and DC. SiriusXM satellite service is also available in Canada; see www.siriusxm.ca.
- It may take some time to receive the activation signal after the initiation of the SiriusXM Satellite Radio subscription. After receiving the activation signal, an available channel list will automatically be updated in the radio. Change the position of the power switch from LOCK to ACC to update the SiriusXM channel list.

USB MEMORY DEVICE PLAYER

Connecting USB memory device



WARNING

Do not connect, disconnect or operate the USB device while driving. Doing so can be a distraction. If distracted you could lose control of your vehicle and cause an accident or serious injury.



CAUTION

- **Do not force the USB device into the USB connection port. Inserting the USB device tilted or up-side-down into the port may damage the port. Make sure that the USB device is connected correctly into the USB connection port.**
- **Do not leave the USB cable in a place where it can be pulled unintentionally. Pulling the cable may damage the port.**

Refer to your device manufacturer's owner information regarding the proper use and care of the device.

When compatible storage devices are

plugged into the port, compatible audio files on the storage devices can be played through the vehicle's audio system.

For the location of the USB connection port:

- "USB (Universal Serial Bus) Connection Port and AUX (auxiliary) input jack" (page 1-5)





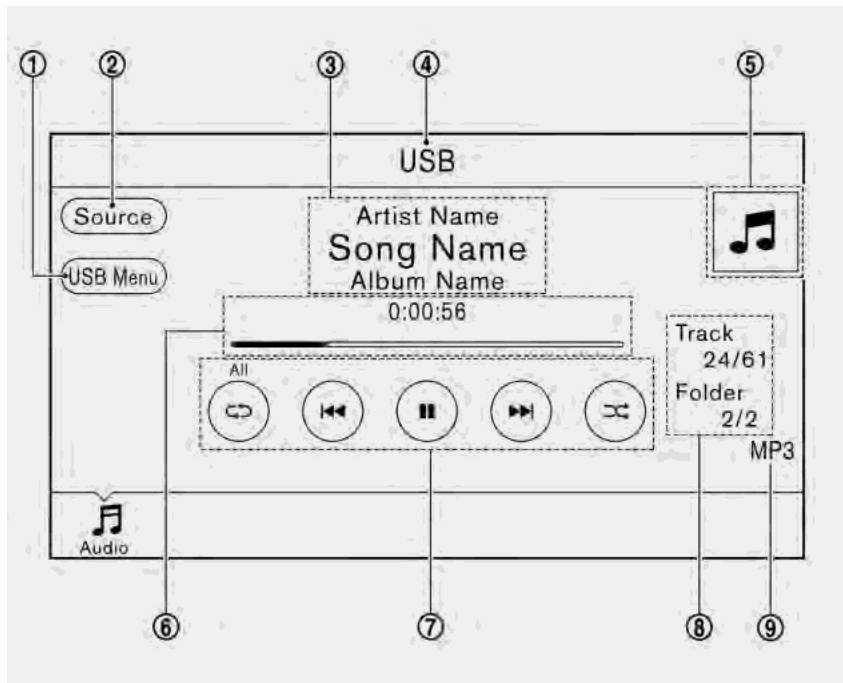





4. Audio system

How to view USB screen



- 1 [USB Menu]:**
Touch to switch to the USB Menu screen.
☞ "USB Menu" (page 4-17)
- 2 [Source]:**
Touch to switch to the source select screen.
☞ "Selecting audio source" (page 4-9)
- 3 Track information:**
Track information such as the song title, artist name and album name are displayed.
- 4 Audio source indicator:**
Indicates that a USB memory device is currently selected among available audio sources.
- 5 Album artwork/Turn direction indicator:**
Image of an album artwork is displayed when available if the setting is turned on.
☞ "USB Menu" (page 4-17)
When the album artwork display setting is turned off, the turn direction and the distance to the next turn are displayed when a route is set with the navigation system.

- ⑥ Play time and progress bar:
The play time of the track is displayed.
The bar indicates the progress in playing a track.
- ⑦ USB operation keys:
Touch an icon for operations.

	Each time [] is touched, the repeat mode changes.  "Changing play mode" (page 4-17)
	Touch to return to the beginning of the current track. Touch again to select the previous track. Touch and hold to rewind the current track.
	Touch to pause the track.
	Touch to play the track.
	Touch to select the next track. Touch and hold to fast-forward the track.
	Each time [] is touched, the random mode changes.  "Changing play mode" (page 4-17)

- ⑧ Track and folder number:
Indicates the track number and the folder number.

- ⑨ Data type indicator:
Indicates the type of data currently playing.



USB memory device player operation

Activation and playing:





Connecting the USB memory device into the port will activate the USB mode.

USB memory device can also be played by selecting the source on the audio source menu screen.

 "Selecting audio source" (page 4-9)

To pause playing the USB memory device, touch []. To resume playing, touch [].

Skipping tracks:

To skip the tracks, push < >/< >, or touch []/[] on the screen repeatedly until preferred track is selected.



INFO:

Depending on the condition, skipping to the previous track may require pushing the button or touching the key twice. Pushing the button or touching the key once may only restart the current track from the beginning.





Changing folders:

To change folders, touch [USB Menu] and touch [Folder List].

 "USB Menu" (page 4-17)

Turn <TUNE-SCROLL/SOUND> to skip to different folders. If no folders are found, tracks will be skipped.

Fast-forwarding/rewinding:

To rewind or fast-forward the track, push and hold < >/< >, or touch and hold []/[].

Changing play mode:

Repeat mode

Touch [] on the screen to change the repeat mode as follows.

[All] → [1 Track] → [1 Folder] → [All]

Random mode

Touch [] on the screen to change the random mode as follows.

(off) → [1 Folder] → [All] → (off)

USB Menu

Touch [USB Menu] on the USB screen to display the USB Menu screen.

The following items are available.

4. Audio system

[Now Playing]	Touch to display the USB screen.
[SCAN]	Touch to scan the tracks in the USB memory device. During scanning, the first several seconds of all the tracks will be played. Touching [Scan] again will cancel the scanning mode and the USB memory device will return to play normally from the track which is playing.
[Folder List] *	Touch to display the folder list. Touch an item on the list to select the folder. Touch [>] and go back to the previous screen to select tracks in the folder.
[Album Artwork]	Touch to turn on/off the album artwork display on the USB screen.
Track List	A list of the tracks in the USB is displayed. Touch an item on the list to select the track.

*: Displayed only when available.

iPod® PLAYER

Connecting iPod®



WARNING

Do not connect, disconnect or operate the USB device while driving. Doing so can be a distraction. If distracted you could lose control of your vehicle and cause an accident or serious injury.



CAUTION

- **Do not force the USB device into the USB connection port. Inserting the USB device tilted or up-side-down into the port may damage the port. Make sure that the USB device is connected correctly into the USB connection port.**
- **Do not leave the USB cable in a place where it can be pulled unintentionally. Pulling the cable may damage the port.**

Connect the iPod® to the USB connection port.

 "USB (Universal Serial Bus) Connection Port and AUX (auxiliary) input jack" (page 1-5)

The battery of the iPod® will be charged while the device is connected to the vehicle if the iPod® supports charging via a USB connection.

Depending on the device and firmware version of the iPod®, the display on the iPod® shows a NISSAN or Accessory Attached screen when the connection is completed. When the iPod® is connected to the vehicle, the iPod® music library can only be operated by the vehicle audio controls.

Compatibility:

Made for

- iPod® (5th generation)
- iPod touch® (4th generation)
- iPod touch® (3rd generation)
- iPod touch® (2nd generation)
- iPod touch® (1st generation)
- iPod classic® (80G/160GB)
- iPod classic® (120GB)
- iPod nano® (7th generation)
- iPod nano® (6th generation)
- iPod nano® (5th generation)

- iPod nano® (4th generation)
- iPod nano® (3rd generation)
- iPod nano® (2nd generation)
- iPod nano® (1st generation)
- iPhone® 6s Plus
- iPhone® 6s
- iPhone® 6 Plus
- iPhone® 6
- iPhone® 5s
- iPhone® 5c
- iPhone® 5
- iPhone® 4S
- iPhone® 4
- iPhone® 3GS
- iPhone® 3G
- iPhone®

 **INFO:**

- Make sure that the iPod® firmware is updated.
- The Lightning™ connector works with iPhone® 5, iPod touch® (5th generation), and iPod nano® (7th generation). The 30-pin connector works with

iPhone® 4S, iPhone® 4, iPhone® 3GS, iPhone® 3G, iPhone®, iPod touch® (1st through 4th generation), iPod classic® and iPod nano® (1st through 6th generation).

USB works with iPhone® 5, iPhone® 4S, iPhone® 4, iPhone® 3GS, iPhone® 3G, iPhone®, iPod touch® (1st through 5th generation) iPod classic® and iPod nano® (1st through 7th generation).

- Refer to your device manufacturer's owner information regarding the proper use and care of the device.

4. Audio system

How to view iPod® screen

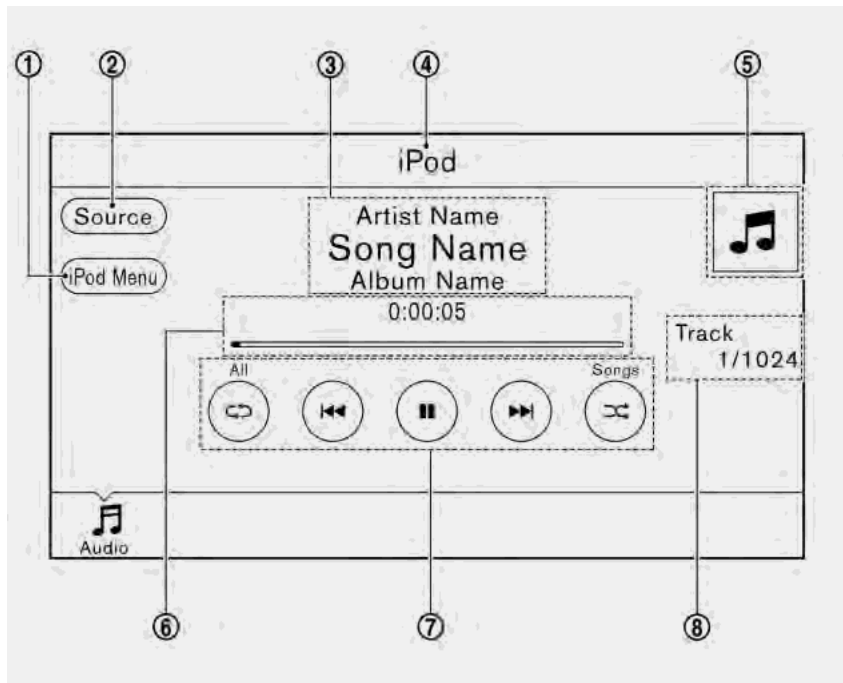











- 1 [iPod Menu]:**
Touch to display the iPod® Menu screen.
👉 "iPod® Menu" (page 4-21)
- 2 [Source]:**
Touch to switch to the source list screen.
👉 "Selecting audio source" (page 4-9)
- 3 Track information:**
Track information such as the song title, artist name and album name are displayed.
- 4 Audio source indicator:**
Indicates that iPod® is currently selected among available sources.
- 5 Album artwork/Turn direction indicator:**
Image of an album artwork is displayed when available if the setting is turned on.
👉 "iPod® Menu" (page 4-21)
When the album artwork display setting is turned off, the turn direction and the distance to the next turn are displayed when a route is set with the navigation system.

⑥ Play time and progress bar:

The play time of the track is displayed. The progress bar indicates the progress in playing the current track.

⑦ iPod® operation keys:

Touch an icon for operations.

	Each time  is touched, the mode changes.  "Changing play mode" (page 4-21)
	Touch to return to the beginning of the current track. Touch again to select the previous track. Touch and hold to rewind the current track.
	Touch to pause the track.
	Touch to play the track.
	Touch to select the next track. Touch and hold to fast-forward the track.
	Each time  is touched, the mode changes.  "Changing play mode" (page 4-21)

⑧ Track number:

Indicates the track number and the total number of tracks.

iPod® player operation

Activation and playing:

Connecting iPod® to the vehicle via USB cable will activate the iPod® mode.

The iPod® can also be played by selecting the source on the audio source menu screen.





 "Selecting audio source" (page 4-9)

Selecting search method:

A list of search methods is displayed in the iPod® menu.

Touch [iPod Menu] to display the iPod® menu. Touch and select an item to play the iPod® in your preferred settings.

Skipping tracks:

To skip the tracks, push <  >/<  >, or touch []/[] on the screen repeatedly until preferred track is selected.







INFO:

Depending on the condition, skipping to the previous track may require pushing the button or touching the key twice. Pushing the button or touching the key once may only restart the current track from the beginning.

Turning <TUNE-SCROLL/SOUND> while a track is playing will also skip the tracks.

Fast-forwarding/rewinding:

To fast-forward or rewind the track, push and hold <  >/<  >, or touch and hold []/[].

Changing play mode:

Repeat mode

Touch [] on the screen to change the repeat mode as follows.

(off) → [One] → [All] → (off)

Random mode

Touch [] on the screen to change the random mode as follows.

(off) → [Songs] → [Albums] → (off)

iPod® Menu

Touch [iPod Menu] on the iPod® screen to display the iPod® menu screen.

The following items are available.

4. Audio system

[Now Playing]	Touch to display the iPod® screen.
[Current List]	Touch to display the menu list which was displayed most recently.
[Album Artwork]	Touch to turn on/off the album artwork display on the iPod® screen.
[Playlists]	Touch to display the playlist and touch an item on the list to select the playlist.
[Artists]	Touch to display the artist list and touch an item on the list to select the artist.
[Albums]	Touch to display the album list and touch an item on the list to select the album.
[Songs]	Touch to display the song list and touch an item on the list to select the song.
[Podcasts]	Touch to display the podcast list and touch an item on the list to select the podcast.
[Genres]	Touch to display the genre list and touch an item on the list to select the genre.
[Composers]	Touch to display the composer list and touch an item on the list to select the composer.

[Audio-books]	Touch to display the audio-book list and touch an item on the list to select the audio-book.
---------------	--



INFO:

On the list screen, touch and hold [⤴] or [⤵] on the right side of the screen to jump by letter for faster scrolling.

BLUETOOTH® AUDIO

Your vehicle is equipped with Bluetooth® Audio.

If you have a compatible Bluetooth® device with streaming audio (A2DP profile), you can set up a wireless connection between your Bluetooth® device and the in-vehicle audio system. This connection allows you to listen to the audio from the Bluetooth® device using your vehicle speakers. It also may allow basic control of the device for playing and skipping audio files using the AVRCP Bluetooth® profile. Not all Bluetooth® devices have the same level of controls for AVRCP. Please consult the manual for your Bluetooth® device for more details.

Wireless LAN (Wi-Fi) and the Bluetooth® functions share the same frequency band (2.4 GHz). Using the Bluetooth® and the wireless LAN functions at the same time

may slow down or disconnect the communication and cause undesired noise. It is recommended that you turn off the wireless LAN (Wi-Fi) when using the Bluetooth® functions.

Connecting Bluetooth® audio device

A Bluetooth® audio device must be connected to the vehicle before operation.

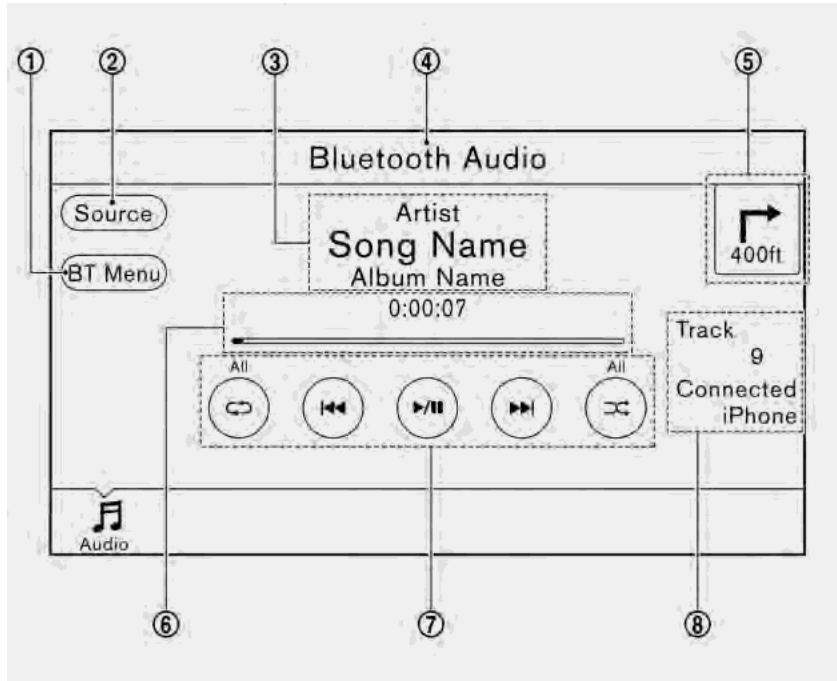

"Connecting Bluetooth® device" (page 1-18)

How to view Bluetooth® audio screen



- ① [BT Menu]:
Touch to display the Bluetooth® audio menu screen.
☞ "BT Menu" (page 4-25)
- ② [Source]:
Touch to switch to the source list screen.
☞ "Selecting audio source" (page 4-9)
- ③ Track information:
Track information such as the song title, artist name and album name are displayed.
- ④ Audio source indicator:
Indicates that Bluetooth® audio is currently selected among available sources.
- ⑤ Turn direction indicator:
When a route to the destination is set, the turn direction and the distance to the next turn are displayed.
- ⑥ Play time and Progress bar:
The play time of the track is displayed. The Progress bar indicates the progress in playing the current track.
- ⑦ Bluetooth® audio operation keys:
Touch an icon for operations.

4. Audio system

[↺]	Each time [↺] is touched, the repeat mode changes.  "Changing play mode" (page 4-24)
[⏮]	Touch to return to the beginning of the current track. Touch again to select the previous track. Touch and hold to rewind the current track.
[▶ / ⏸]	Touch to play and pause the track.
[⏭]	Touch to select the next track. Touch and hold to fast-forward the track.
[↻]	Each time [↻] is touched, the random mode changes.  "Changing play mode" (page 4-24)

- ⑧ Track number and device name:
Indicates the track number and the selected Bluetooth® device name.



INFO:

Depending on the audio device that is connected to the vehicle, track information may not be displayed.

Bluetooth® audio operation

The ability to pause, change tracks, fast forward, rewind, randomize and repeat music may be different between devices. Some or all of these functions may not be supported on each device.



INFO:

Depending on the Bluetooth® audio device that is connected, it may not be possible to perform audio operations or a time lag may occur before music is played back.

Activation and playing:

A Bluetooth® audio device can be played by selecting the source on the audio source menu screen.

 "Selecting audio source" (page 4-9)

To pause playing the Bluetooth® audio, touch [▶ / ⏸]. Touch again to resume playing.

Skipping tracks:

Push <⏮>/<⏭>, or touch [⏮]/[⏭] on the screen briefly to skip to the next or the previous track.



INFO:

Depending on the condition, skipping to the previous track may require pushing the button or touching the key twice. Pushing the button or touching the key once may only restart the current track from the beginning.

Turning <TUNE-SCROLL/SOUND> will also skip the tracks.

Changing folders:

To change folders, touch [BT Menu] and touch [Folder List].

 "BT Menu" (page 4-25)

Fast-forwarding/rewinding:

To fast-forward or rewind the track, push and hold <⏮>/<⏭>, or touch and hold [⏮]/[⏭].

Changing play mode:

Repeat mode

Touch [↺] on the screen to change the repeat mode.

Random mode

Touch [∞] on the screen to change the random mode.

**INFO:**

Available repeat/random modes change depending on the connected device.

BT Menu

Touch [BT Menu] on the Bluetooth® audio screen to display the Bluetooth® audio menu screen.

The following items are available.

[Now Playing]	Touch to display the Bluetooth® audio screen.
[Bluetooth Settings]	Touch to display the Bluetooth® settings screen. ☞ "Bluetooth® settings" (page 1-18)
[Folder List] *	Touch to display the folder list. Touch an item on the list to select the folder.
Track List	A list of the tracks is displayed. Touch an item on the list to select the track.

*: Displayed only when available.

AUXILIARY (AUX) DEVICES**Connecting auxiliary devices**

For the location of the auxiliary input jack:
☞ "USB (Universal Serial Bus) Connection Port and AUX (auxiliary) input jack" (page 1-5)

The auxiliary input jack accepts any standard analog audio input such as from a portable cassette player, CD player or MP3 player.

**INFO:**

Insert a 1/8 in (3.5 mm) stereo mini plug in the audio input jack. If a cable with a mono plug is used, the audio output may not function normally.

AUX operation**Activation and playing:**

Turn on an AUX device.

Connect an AUX cable to the AUX device and the AUX jack. Select AUX mode from the audio source menu screen.

☞ "Selecting audio source" (page 4-9)

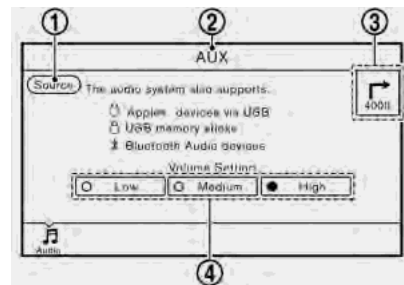
How to view AUX screen

- ① [Source]:
Touch to switch to the source list screen.
☞ "Selecting audio source" (page 4-9)
- ② Audio source indicator:
Indicates that an AUX device is currently selected among other sources.
- ③ Turn direction indicator:
When a route to the destination is set, the turn direction and the distance to the next turn are displayed.
- ④ Volume Setting keys:
Touch one of the keys to select the sound output gain from [Low], [Medium] and [High].

4. Audio system

AUDIO SETTINGS

Audio settings can be adjusted or audio related functions can be turned on/off with the following procedure.

1. Touch [Settings] on the Launch Bar.
2. Touch [Sound].

Setting items	Action
[Bass]	Adjust the speaker tone quality and sound balance by touching [+] / [-], [L] / [R] or [R] / [F].
[Treble]	
[Balance]	
[Fade]	
[Speed Sensitive Volume]	Automatically adjusts the volume depending on the vehicle speed. Touch [+] / [-] to change the sensitivity level.

AUDIO ADJUSTMENTS WHEN MAP, AUDIO OR HOME MENU IS DISPLAYED

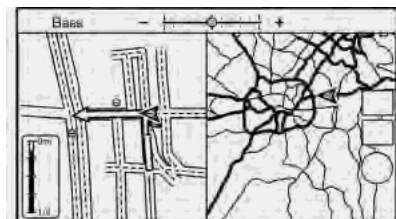

When the Map, Audio or HOME MENU screen is displayed, some audio settings can be adjusted with **<TUNE-SCROLL/SOUND>**. Each time **<TUNE-SCROLL/SOUND>** is pushed, the selected setting item will change as follows.

[Bass] → [Treble] → [Balance] → [Fade]

Rotate **<TUNE-SCROLL/SOUND>** to adjust the level of the selected setting item.



INFO:

This function may not be available when a menu is highlighted on the screen.

5 NissanConnect® EV and Services

Telematics overview	5-2	NissanConnect® EV and Services menu	5-11
NissanConnect® EV and Services	5-4	Connecting to Interactive Voice Menu	5-12
Subscription to NissanConnect® EV and Services	5-4	Viewing information feeds	5-12
Legal disclaimer	5-4	Storing favorites	5-14
NissanConnect® EV and Services features	5-4	Viewing NissanConnect® EV and Services records	5-14
Radio approval number and information	5-5	Emergency support	5-15
Available services	5-6	Making an emergency call	5-16
Notice to Bluetooth® Hands-Free Phone users	5-9	NissanConnect® EV and Services settings	5-17
Service application	5-9	Error message on communication	5-21
Operating tips	5-9		

5. NissanConnect® EV and Services

TELEMATICS OVERVIEW

In addition to Event Data Recorders (EDRs) mentioned in the LEAF Owner's Manual, this vehicle is equipped with electronic modules that monitor, control and record data concerning various vehicle systems, including the motor, batteries, braking and electrical systems. Other electronic modules record information concerning driving conditions, including idling, braking, acceleration, trip and other related data, information about your use of the car and its features such as air conditioner or headlight usage, diagnostic trouble codes, vehicle charging, vehicle speed, direction and/or location.

Some of this data is stored by the vehicle for use during vehicle servicing. Other data concerning your vehicle's operation and performance is wirelessly transmitted by cellular connection through the vehicle onboard telematics system upon vehicle start-up or at other intervals to NISSAN. This data may be used by NISSAN for various purposes, including: to provide you with NissanConnect® EV and Services; troubleshooting; evaluation of your vehicle's quality, functionality and performance; analysis and research by NISSAN designed to, among other things, optimize performance of future electric vehi-

cles including improvements in future battery life; to offer you new or additional products or services; and as otherwise may be required by law. Such data may be shared with NISSAN's parents, subsidiaries, affiliates, successors or assignees; authorized NISSAN certified LEAF dealers; NISSAN's marketing partners; your fleet company, if your vehicle is a fleet vehicle; your rental company, if your vehicle is a rental vehicle; and third party service providers such as cellular, information systems and data management providers.

State and provincial laws allow access and use of data recorded by vehicle devices with the consent of the vehicle owner or pursuant to subscription agreement. While you are not required to allow such access and use, if you do not so agree NISSAN may be unable under applicable law to activate the vehicle telematics system in your vehicle, and certain features of your vehicle which are dependent on vehicle telematics will not operate as intended or designed. These may include features such as automatic charging station map updates, remote battery state of charge check, charging complete notice, remote plug in reminder, remote charging on, remote climate control on, drive route planning, driving tips to im-

prove range, driving history, billing simulation, ECO ranking, maintenance reminders, etc. Other features that may be developed and offered by NISSAN in the future may also not function without telematics data transmission.

NissanConnect® EV and Services telematics services are provided by NISSAN pursuant to a subscription services agreement covering your vehicle. This agreement is necessary for all owners. This agreement, and an explanation of its terms and conditions, can be found at the NissanConnect® Website. Further, the operator of the vehicle must also touch [OK] on the Navi screen to indicate assent when requested. If you decide at any time that you do not want your vehicle to transmit data to NISSAN, you can deactivate the telematics account associated with this vehicle by canceling the subscription services agreement by visiting the NissanConnect® Website or calling NISSAN at 1-877-NOGASEV (1-877-664-2738). The service can be reactivated later upon request if you choose. Simply visit the same website or call the number above. Alternatively, you can turn off the transmission of certain categories of data through the use of settings found in the Navigation system under Menu, NissanConnect® EV and Services, Vehicle Infor-

5. NissanConnect® EV and Services

mation Sharing with NISSAN. Note, turning off "Vehicle Information Sharing with NISSAN" will only disable the automatic sharing of information at vehicle start-up. Certain categories of data may still be transmitted if vehicle telematics features are accessed either in the vehicle or remotely.

Your agreement to the transmission and use of data by NISSAN can be provided in various ways. The vehicle is equipped with a "pop up" screen on the vehicle navigation system that will ask for your consent to this data transfer. A version of the following message will appear: "Pursuant to subscription agreement, your vehicle wirelessly transmits recorded vehicle data to NISSAN for various purposes, including NissanConnect® EV and Services, product evaluation, research and development. By touching [OK], you consent to the transmission and use of your vehicle data. See Owner's Manual or NissanConnect® Website for terms and details." If you touch [OK], your vehicle will transmit data as designed in connection with the vehicle telematics system. If you touch [Decline] your vehicle will not transmit data. However, the telematics features referenced above, and perhaps others, will not be available to you. The vehicle's static navigation system will remain operational,

and you will be able to access your radio and climate controls.

Telematics features are dependent on cellular data transmission. Some areas may have limited or no cellular connectivity, resulting in a loss or interruption of data transmission and, as a result, certain features may be temporarily unavailable. Even if areas with good signal reception, cellular connectivity can be adversely affected by things such as tall buildings, apartments, tunnels, underground parking, mountainous areas, etc. Even if the signal strength bar of the in-vehicle data communication module indicates good reception, connectivity may be disrupted. This does not indicate a malfunction. Operate the system again after a few minutes to restore connectivity. NissanConnect® EV and Services telematics features are offered as a convenience to the vehicle owner. NISSAN is not responsible for, and owner assumes all risk of, interruptions in service or errors based on incomplete or inaccurate data. NissanConnect® EV and Services communications may be received at a verified e-mail address or by SMS/text messaging-enabled mobile phone. Standard text rates and/or data usage may apply depending on your carrier.

If your vehicle's telematics account is

active, and you are not the original owner, please contact NISSAN at the website or phone number above as soon as possible to update the telematics enrollment information. Upon sale of the vehicle, please contact NISSAN at the website or phone number above so that NISSAN's records may be updated. NissanConnect® EV and Services subscription will automatically terminate at the end of the initial free term if you do not wish to renew your subscription agreement at the prices then in effect.

5. NissanConnect® EV and Services

NISSANCONNECT® EV AND SERVICES

SUBSCRIPTION TO NISSANCONNECT® EV AND SERVICES

Except for services received under Demonstration Mode, it is necessary to subscribe to NissanConnect® EV and Services in order to use the NissanConnect® EV and Services. To activate NissanConnect® EV and Services, you can enroll via the NissanConnect® EV and Services Companion App, NissanConnect® portal website, or it is recommended you contact a NISSAN certified LEAF dealer.

NissanConnect® EV and Services are offered by SiriusXM or other third party vendors in accordance with the terms and conditions and privacy policies outlined in a Subscription Agreement.

LEGAL DISCLAIMER

Avoid operating NissanConnect® EV and Services in such a way that you are distracted while driving. Except for services provided under Demonstration Mode, a NissanConnect® EV and Services Subscription Agreement is required to use this service.

Beginning on the date of purchase of your vehicle, a trial period for the services is

included for a limited period of time. At the expiration of the trial subscription period, your credit card will be charged if there is a credit card on file, and your service will automatically renew in accordance with the terms of your NissanConnect® EV and Services Subscription Agreement.

Services are dependent upon subscription enrollment and the telematics device being in operative condition, cellular connection availability, navigation map data, and GPS satellite signal reception, which can limit the ability to reach NissanConnect® EV and Services or to receive support. The service requires a compatible 3G/4G (LTE) cellular network. Should the cellular provider terminate or restrict network service, services will not be available. Under this circumstance, your service may be suspended or terminated without notice and without liability to NISSAN, NISSAN's third party service providers, the underlying wireless carrier or any third party beneficiary. In the event that a change of telecommunications systems or services becomes necessary, you are solely responsible for replacing, as well as the cost of replacing, any equipment in the vehicle that is necessitated. Terms and conditions of NissanConnect® EV and Services Subscription Agreement apply.

NISSANCONNECT® EV AND SERVICES FEATURES

NissanConnect® EV and Services provides various types of information and services by connecting your vehicle to the NissanConnect® EV and Services Data Center and NissanConnect® EV and Services Response Center using the TCU (Telematics Control Unit) installed in your vehicle.



WARNING

- **Radio waves could adversely affect electric medical equipment. Individuals who use a pacemaker should contact the device manufacturer regarding any possible effects before using the system.**
- **The TCU antenna is installed inside the upper central part of the instrument panel. An occupant should not get any closer to the antenna than specified by the pacemaker manufacturer. The radio waves from the TCU antenna may adversely affect the operation of the pacemaker while using the NissanConnect® EV and Services.**

5. NissanConnect® EV and Services

- Please note that the Automatic Collision Notification (ACN) service and Emergency Calling (E-Call) function cannot be used in the following conditions:
 - The vehicle moves outside the NissanConnect® EV and Services area and connection with the TCU (Telematics Control Unit) is affected.
 - The vehicle is in a location with poor signal reception such as a tunnel, underground parking, behind a building or in a mountainous area.
- It may not be possible to make an emergency call depending on the severity of a collision and/or emergency.
- Emergency functions and services will not be available without a paid subscription to NissanConnect® EV and Services.
- The Automatic Collision Notification (ACN) service may not function properly depending on the severity of a collision and/or emergency.



INFO:

- NissanConnect® EV and Services features are dependent upon subscription enrollment and the telematics device being in operative condition, cellular connectivity, navigation map data and GPS satellite signal reception. Terms and conditions of the NissanConnect® EV and Services Subscription Agreement apply.
- Enrollment is required in order to receive NissanConnect® EV and Services. The services that can be received vary depending on the plan in which you are enrolled.
- A trial period is included beginning on the date of purchase, however you must still be enrolled and activated to use services.
- After the trial period, you must enroll in a paid subscription for NissanConnect® EV and Services to continue using the features. The services that can be received vary depending on the plan to which you subscribe.
- Laws in some jurisdictions may restrict the use of "Text-to-Speech." Check local regulations before using this feature.

NissanConnect® EV and Services may be updated. The latest detailed information is available on the following websites or from the support line.

NissanConnect® Website:

For U.S.

www.nissanusa.com/connect

For Canada

www.nissan.ca/nissanconnect
(English)

www.nissan.ca/nissanconnect/fr
(French)

NissanConnect® support line:

1-877-664-2738

RADIO APPROVAL NUMBER AND INFORMATION

- FCC ID:
 - 25915 5SA0A(QY8600): WY2QY8600
 - 25915 5SA1A(QY8650): WY2QY8600
- IC ID:
 - 25915 5SG0A(QY8601): 419E-QY8601
 - 25915 5SG1A(QY8651): 419E-QY8601

5. NissanConnect® EV and Services

AVAILABLE SERVICES

- **Remote Battery Status Check:**

The status of the battery can be checked using your personal computer or cellular phone even if you are not in the vehicle.

- **Unplugged Status, Charge Complete Notification:**

By registering frequently used charging stations, notifications can be sent to your personal computer or cellular phone e-mail address to inform you when the charging connector is disconnected at those locations or charging is completed.

- **Remote Start Charge, Remote Climate Control:**

Remote activation of battery charging or climate control can be set using your personal computer or cellular phone.

- **Li-ion battery warmer status (if so equipped):**

When the ambient temperature is low, the Li-ion battery warmer operates automatically.

Notifications will be sent to your personal computer or cellular phone e-mail address under the following conditions in order to remind you to

connect the charging connector.

- Approximately 5 minutes after the Li-ion battery warmer starts operating while the power switch is in the OFF state and the charging cable is not connected to the vehicle.
- Approximately 5 minutes after the Li-ion battery warmer stops operating due to low remaining Li-ion battery power while the power switch is in the OFF state and the charging cable is not connected to the vehicle.



NOTE:

- **The remaining Li-ion battery power lowers gradually while the battery warmer is operating without connecting the charging connector.**
- **When the remaining Li-ion battery power lowers, the battery warmer stops operating. When this occurs, the Li-ion battery temperature lowers gradually, and as a result the EV system may be disabled.**
- **Automatic update of charging stations:**
The information for the charging stations that is recorded in the map data

is automatically updated.

- **My Car Finder:**

Location of your vehicle can be checked on your personal computer or cellular phone.

- **Changing Station Map Update:**

Charging station information on the map can be updated on your personal computer or cellular phone.

- **Driving History:**

Driving history can be checked on your personal computer or cellular phone.

- **Charging Station Availability:**

Charging station facility location and information can be checked on your personal computer or cellular phone.

- **Check Cabin Temperature:**

The temperature inside your vehicle can be checked on your personal computer or cellular phone.

- **Set Cabin Temperature:**

The temperature setting of the remote climate control can be changed on your personal computer or cellular phone.

- **Emergency Calling (E-Call):**

The Emergency Calling (E-Call) feature provides emergency assistance by

connecting to a Response Specialist. In the event of an emergency, by push **<SOS>** to use this feature. The Response Specialist provides various assistance depending on the situation.

 "Emergency support" (page 5-15)

- **Automatic Collision Notification (ACN):**

The TCU (Telematics Control Unit) generates a signal automatically to the NissanConnect® EV and Services Response Center in the case of an accident severe enough to trigger one of the vehicle's air bags. Upon the signal, a Response Specialist receives the vehicle location and customer information and notifies the proper authorities in accordance with established policies and procedures.

- **Curfew Alert:**

Customers can set time interval for acceptable and unacceptable operation of the vehicle via NissanConnect® Website and Companion App. If the time restrictions are violated, the customer will be automatically notified (e-mail, text message or phone call).

- **Remote Door Lock/Unlock:**

The Remote Door Lock/Unlock feature allows the customer to access the vehicle remotely from the NissanCon-

nect® Website or Companion App to send lock or unlock commands to the vehicle.

- **Remote Sound Horn and Flash Lights:**

Customers can activate the vehicle's headlights and horn via the NissanConnect® Website or Companion App.

- **Alarm Notification:**

Customers will be notified if the vehicle alarm system is activated based on their notification preferences (e-mail, text message or phone call).

- **Boundary Alert:**

Customers can set an area for the vehicle to stay in or out of via the NissanConnect® Website or Companion App. Customers will be notified when vehicle is out-of-bounds based on their notification preferences (e-mail, text message or phone call).

- **Maintenance Alert/Reminder:**

The center sends maintenance and other relevant info. to registered e-mail address (PC/Mobile) based on the vehicle information (e.g. driving mileage and etc.) sent at the center access timing. Details of vehicle information are separately examined.

- **Send to Car:**

Customers can access turn-by-turn navigation provided by Google maps and sent directly to the NissanConnect® vehicle.

- **Journey Planner:**

Customers can create a multiple way-point route via Journey Planner on the NissanConnect® Website and send the details directly to their vehicle.

- **Connected Search:**

Customers can access Internet search engines directly from the vehicle to find exact destinations to navigate to.

- **Stolen Vehicle Locator:**

In the event that the customer's vehicle is stolen, after filing a police report the customer can contact NissanConnect® EV and Services Response Center via phone and report the vehicle stolen. At that point, NissanConnect® EV and Services emergency support staff will work with authorities to attempt to recover the vehicle.

- **Valet Alert:**

Customers will be notified if their vehicle is driven more than 0.2 miles (0.4 km) once they activate Valet Alert via the NissanConnect® Website or Companion App.

5. NissanConnect® EV and Services

● **Roadside Assistance Service:**

Enhanced Roadside Assistance allows you to receive assistance from the Roadside Response Specialist for a non-emergency incident that requires a towing or third-party response service. The service is accessed by touching the Voice Menu button on the navigation screen. Roadside Assistance may also be used in conjunction with the Emergency Assistance service, if warranted.

 "Emergency support" (page 5-15)

● **Speed Alert:**

Max Speed Alert allows you to monitor the speed of your vehicle by receiving alerts. You can set the maximum speed via the NissanConnect® Website, and if your vehicle exceeds the specified speed threshold, you will receive a notification via the chosen method. You can also query the NissanConnect® Website to view a listing of Max Speed Alert notifications.



NOTE:

- **Completing the NissanConnect® EV and Services registration is necessary before using this service.**
- **To check the Li-ion battery charging status or to use the remote heater and air conditioner using an internet enabled smart phone or personal computer, the following conditions must be met:**
 - **The vehicle must be located in a cellular phone or smart phone coverage area.**
 - **The internet enabled cellular phone or smart phone must be located in a cellular phone or smart phone coverage area.**
 - **The computer must be connected to the internet.**
 - **A cellular phone capable of text messaging must be used to receive text message regarding vehicle charge status.**
- **When the charge connector is disconnected from the vehicle, the heater and air conditioner operates using vehicle Li-ion battery electric power.**

- **If the remote heater and air conditioner function and Li-ion battery charging are performed at the same time, Li-ion battery charging will take longer than usual due to the power used to heat or cool the vehicle.**
- **Certain remote functions require a compatible smart phone, which is not included with vehicle.**
- **NissanConnect® EV and Services information system features are included through a subscription service which requires owner consent to activate. The subscription must be active to use these features.**
- **NissanConnect® EV and Services communications may be received at a verified e-mail address or by SMS/text messaging-enabled cellular phone.**
- **Standard text rates and/or data usage may apply depending on your carrier.**

5. NissanConnect® EV and Services

NOTICE TO BLUETOOTH® HANDS-FREE PHONE USERS

The Bluetooth® Hands-Free Phone System will be disabled and not be able to take phone calls while the vehicle is connected to the NissanConnect® EV and Services Response Specialists or the emergency support staff at the NissanConnect® EV and Service Response Center. This is to avoid various services by NissanConnect® EV and Services Response Specialists (such as Assisted Search) and NissanConnect® EV and Services emergency support staff being interrupted by incoming calls. Incoming phone calls received while the vehicle is connected to the Service Center will not be listed in the call history of the Bluetooth® Hands-Free Phone System. However those incoming calls may be listed in the call history of your mobile phone, depending on its capabilities. After disconnecting communication with the NissanConnect® EV and Services Response Specialist or NissanConnect® EV and Services emergency support staff, check the incoming call history on your mobile phone when it is safe to do so.

SERVICE APPLICATION

A separately purchased NissanConnect® EV and Services subscription is required. For more details, refer to the NissanConnect® Website or contact the NissanConnect® support line.

NissanConnect® Website:

For U.S.

www.nissanusa.com/connect

For Canada

www.nissan.ca/nissanconnect
(English)

www.nissan.ca/nissanconnect/fr
(French)

NissanConnect® support line:

1-877-664-2738



INFO:

If the vehicle is owned by another person and is resold, the subscription for this service must be canceled and all data stored on the device must be deleted.

OPERATING TIPS



WARNING

- **Use NissanConnect® EV and Services after stopping your vehicle in a safe location. If you have to use NissanConnect® EV and Services while driving, exercise extreme caution at all times so full attention may be given to vehicle operation.**
- **If you are unable to devote full attention to vehicle operation while talking with the NissanConnect® EV and Services, pull off the road to a safe location and stop your vehicle.**
- Do not use NissanConnect® EV and Services with the EV system stopped. Doing so may discharge the vehicle battery.
- NissanConnect® EV and Services cannot be used under the following conditions:
 - NissanConnect® EV and Services subscription has expired.
 - The vehicle is outside the area where the cellular network service

5. NissanConnect® EV and Services

is receivable.

- The vehicle is in a location with poor signal reception such as tunnels, underground parking garages, behind buildings or in mountainous areas.
- The line is busy.
- The TCU (Telematics Control Unit) or other systems of your vehicle are not working properly.
- The NissanConnect® EV and Services network system is disabled.
- Information Feeds download cannot be used when the vehicle is connected to the NissanConnect® EV and Services Data Center and NissanConnect® EV and Services Response Center.
- Communication with the NissanConnect® EV and Services Data Center is related to the data communication mode and may cause occasional difficulty in receiving signals, and the signal receivable area may be limited compared to regular mobile phones.
- You may hear clicks or experience interruptions while speaking with the NissanConnect® EV and Services Response Specialists. This is due to a shift in the connection zone and is not a

malfunction.

- Depending on the line used, the sound volume may decrease. Adjust the volume as necessary.
- Received sounds may be distorted or ambient noise may sound like voices of a crowd. This is due to the use of the digital line and is not a malfunction.
- You may hear your own voice from the speaker when talking with the NissanConnect® EV and Services Response Specialists due to a network disturbance. When this occurs, reconnect the line after a few minutes or at a different location.
- This vehicle incorporates a communication device that is called a TCU (Telematics Control Unit). The communication connection between this unit and the NissanConnect® EV and Services Data Center allows for various services. When the system connects to the NissanConnect® EV and Services Data Center, an antenna icon will appear in the upper right corner of the screen. Use the service in a location where the symbol representing good signal reception appears on the screen.

 : When the signal reception is good

 : When the signal reception is bad

- NissanConnect® EV and Services uses the TCU (Telematics Control Unit). Even if the signal strength bar of the in-vehicle data communication module indicates good reception, connection to the NissanConnect® EV and Services Data Center may be disabled. This does not indicate a malfunction. Operate the system again after a few minutes.

INFO:

You can check driving records for your vehicle online at the NissanConnect® Website.

However, if [Share Vehicle Information] is set to OFF, vehicle data will not be uploaded. Make sure that this setting is ON.



When [Service Reminders] is set to ON, communication with the NissanConnect® EV and Services Data Center will be performed once daily. NISSAN recommends that you set [Service Reminders] to ON.





 "NissanConnect® EV and Services settings" (page 5-17)

NISSANCONNECT® EV AND SERVICES MENU

With the NissanConnect® EV and Services, various information can be received and displayed on the screen. The information can also be announced by the system.

1. Touch [Info] on the Launch Bar.
2. Touch [NissanConnect EV & Services].
3. Select an item from the NissanConnect® EV and Services menu screens.

Available items	Content
[Connect to Voice Menu]	The system connects to the NissanConnect® EV and Services center. Various services to support your driving are available by answering Interactive Voice Menu.  "Connecting to Interactive Voice Menu" (page 5-12)
[Favorite Feeds]	Favorite feeds selected from the information feeds can be stored in a folder.  "Storing favorites" (page 5-14)
[Update Stations]	Charging station information can be updated through connection to the Nissan Data Center.  "Updating charging station information" (page 2-7)

[All Information Feeds]	Information feeds can be selected and viewed.  "Viewing information feeds" (page 5-12)
[History]	The information feeds that were referred to previously can be displayed.  "Viewing NissanConnect® EV and Services records" (page 5-14)
[Charging Availability]	Availability of charging stations can be confirmed.  "Confirming charging station availability" (page 2-6)
[Destinations by Google™]	Place information searched by Google can be downloaded and be set as a destination.  "Setting destinations by Google" (page 3-27)

5. NissanConnect® EV and Services

[NissanConnect EV/ Svcs. Settings]	NissanConnect® EV and Services settings can be changed.  "NissanConnect® EV and Services settings" (page 5-17)
------------------------------------	--

CONNECTING TO INTERACTIVE VOICE MENU

Various services to support your driving are available by using Interactive Voice Menu. For more details, refer to the NissanConnect® Website or contact the NissanConnect® support line.

NissanConnect® Website:

For U.S.

www.nissanusa.com/connect

For Canada

www.nissan.ca/nissanconnect
(English)

www.nissan.ca/nissanconnect/fr
(French)

NissanConnect® support line:

1-877-664-2738

1. Touch [Info] on the Launch Bar.

2. Touch [NissanConnect EV & Services].
3. Touch [Connect to Voice Menu].
4. The system connects to the NissanConnect® EV and Services center and menu options will be announced. Speak your preferred option.
 - Destination Assistance
Sets a destination using an Interactive operator system.
 - Roadside Assistance
Connects to the Roadside Response Specialist.
 - Valet Alert
Turns on the Valet Alert function and monitors the vehicle movement within a certain range.
 - Personal Assistance
Connects to the NissanConnect® EV and Services Response Specialist.

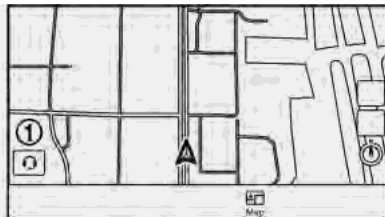

INFO:

- You can also connect to the NissanConnect® EV and Services Interactive Voice Menu by touching the Voice Menu button ① on the map.
- After selecting [Connect to Voice Menu], it may take some time until the system initiates connection, depending on the technical environment and whether the TCU (Telematics Control Unit) is being used by other services.
- To avoid disconnecting the line, do not turn the EV system off.

VIEWING INFORMATION FEEDS

Contents of the various NissanConnect® EV and Services information can be downloaded.

1. Touch [Info] on the Launch Bar.
2. Touch [NissanConnect EV & Services].
3. Touch [All Information Feeds]. A list screen is displayed.
4. Touch a preferred folder. A list of information feeds is displayed. The content is announced by the system (Text-to-Speech) while the vehicle is being driven, or if parked, you can read the content on the display.

INFO:

- Touch [Stop] during communication with the Nissan Data Center to cancel the connection.
- A message is displayed when the communication is disconnected while downloading information due to a poor communication status. Select [Yes] to restart the download.
- Laws in some jurisdictions may restrict the use of "Text-to-Speech." Check local regulations before using this feature.
- Some terminology such as personal names, place names, special terms, symbols, etc. may not be announced correctly. This is not a malfunction.
- The system will pause announcements when interrupted by the voice guidance given by the navigation system. When the voice guidance finishes, the system will restart the announcement.
- The volume can be adjusted when the system announces the information.
 "Volume and Beeps settings"
(page 1-17)

- The selected content is read out while the vehicle is being driven, or if parked, you can read the content on the display.
- Content settings can be made using the NissanConnect® Website. For more details, refer to the NissanConnect® Website or contact the NissanConnect® support line.

NissanConnect® Website:

For U.S.

www.NissanUSA.com/connect

For Canada

www.Nissan.ca/NissanConnect
(English)

www.Nissan.ca/NissanConnect/fr
(French)

NissanConnect® support line:

1-877-664-2738

Screen information

When information is downloaded from the Nissan Data Center, the contents of the information are displayed while the vehicle is stopped.

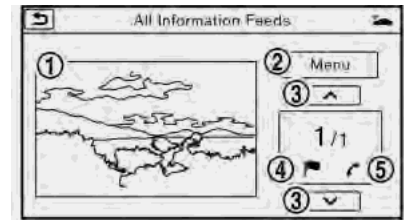

① Contents:

The contents of the NissanConnect® EV and Services feeds are displayed.

② Menu:

Stops the Text-to-Speech voice announcements and displays the operation menu items on the right side of the screen.

③ [^]/[v]:

Turns to the next or previous page if the information has a number of content pages.

④ :

If the information contains map information, the icon be displayed. It can be set as the destination.

⑤ :

If the information contains phone number information, the icon is dis-

5. NissanConnect® EV and Services

played. It is possible to make a phone call to the facility.

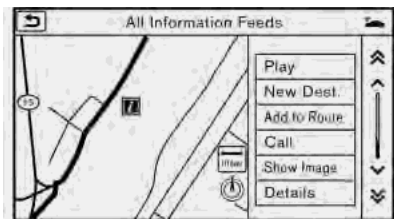

After parking the vehicle in a safe location and touching [Menu], the operation menu is displayed on the right side of the screen.

INFO:

The availability of the operation menu items differs depending on the contents of the selected information.

STORING FAVORITES

Favorite feeds selected from the information feeds can be stored in a folder.

1. Touch [Info] on the Launch Bar and touch [NissanConnect EV & Services].
2. Touch [Favorite Feeds].
3. Touch [Add New]. A folder list is displayed.

4. Touch the preferred folder from the list. An information feed list is displayed.
5. Touch a favorite feed to be stored.
6. Check the contents of the message, then touch [Yes]. When the contents of the information are sent to the Nissan Data Center, the registration is completed.

INFO:

- The contents that are entered in the favorites folder need to be transmitted to the Nissan Data Center. Registration of the contents is not completed until the data is transmitted to the Nissan Data Center.
- A message is displayed if communication is interrupted while downloading information. Touch [Yes] to restart the download.

VIEWING NISSANCONNECT® EV AND SERVICES RECORDS

The information feeds that were referred to previously are displayed. A maximum of 3 feeds can be stored in the history.

1. Touch [Info] on the Launch Bar and touch [NissanConnect EV & Services].

2. Touch [History]. An information feed list is displayed.

INFO:

- When the number of feeds stored in the history reaches the limit, the system deletes the oldest feed and saves a new feed.
- One feed that should not be deleted can be protected. To protect history of information feeds visited, display the screen for the information feed you want to protect and after auto-play has been paused, touch [Lock Feed].
 "Screen information" (page 5-13)

EMERGENCY SUPPORT

NissanConnect® EV and Services provides various services to support dealing with emergencies of the subscribed vehicle and the driver.

For example, in case of an illness or serious injury, you can seek support by pushing <SOS> and connecting to NissanConnect® EV and Services. NissanConnect® EV and Services can specify the location of the vehicle via GPS, and the information will be sent to the police or other agencies as needed.

For information about other NissanConnect® EV and Services emergency support related services, refer to the NissanConnect® Website or contact the NissanConnect® support line.

NissanConnect® Website:

For U.S.

www.nissanusa.com/connect

For Canada

www.nissan.ca/nissanconnect
(English)

www.nissan.ca/nissanconnect/fr
(French)

NissanConnect® support line:

1-877-664-2738



WARNING

- Please note that the Automatic Collision Notification service and Emergency Call function cannot be used in the following conditions:
 - Emergency functions and services will not be available without a paid subscription to NissanConnect® EV and Services.
 - The NissanConnect® EV and Services network system is disabled.
 - The vehicle moves outside the service area where the TCU (Telematics Control Unit) is connected to the system.
 - The vehicle is outside the area where the cellular network service is receivable.
 - The vehicle is in a location with poor signal reception such as tunnels, underground parking garages, behind buildings or in mountainous areas.
 - The line is busy.

- The TCU (Telematics Control Unit) or other systems of your vehicle are not working properly.
- It may not be possible to make an emergency call depending on the severity of a collision and/or emergency.
- Park the vehicle in a safe location and set the parking brake before operating <SOS>.
- Only use this service in case of an emergency. There may be a penalty for inappropriate use of the service.
- Radio waves could adversely affect electric medical equipment. Individuals who use a pacemaker should contact the device manufacturer regarding any possible effects before using the system.
- The TCU (Telematics Control Unit) antenna is installed inside the upper central part of the instrument panel. An occupant should not get any closer to the antenna than specified by the pacemaker manufacturer. The radio waves from the TCU antenna may adversely affect the operation of the pacemaker while using the Nis-

5. NissanConnect® EV and Services

sanConnect® EV and Services.

MAKING AN EMERGENCY CALL

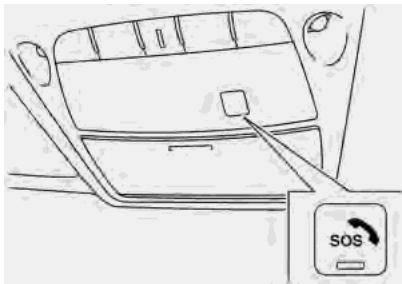

1. Push **<SOS>**.
2. When the line is connected, speak to the Response Specialist.

If you want to cancel the emergency call, push and hold **<SOS>** for a few seconds.

INFO:

- An indicator light on **<SOS>** shows the readiness of the emergency support system. If the indicator light is not illuminated, pushing **<SOS>** does not connect your vehicle to the Response Specialist.
The indicator light blinks while connected to the NissanConnect® EV and Services Response Center.
 - Even when the indicator light is illuminated, connection to the NissanConnect® EV and Services Response Center may not be possible. If this occurs in an emergency situation, contact the authorities by other means.
 - To avoid disconnecting the line, do not turn the EV system off.
- After **<SOS>** is pushed, it may take some time until the system initiates connection, depending on the technical environment and whether the TCU (Telematics Control Unit) is being used by other services.

NISSANCONNECT® EV AND SERVICES SETTINGS

The NissanConnect® EV and Services setting can be changed.

1. Touch [Info] on the Launch Bar.
2. Touch [NissanConnect EV & Services].
3. Touch [NissanConnect EV/Svcs. Settings].



INFO:

[NissanConnect EV & Services] can also be accessed from [Settings] on the Launch Bar.

"Setting menu" (page 1-15)

Setting items		Action	
[Charging Messages]		Sends a notification to a preset e-mail address. This notification includes the charge connector status and the charge completion. To receive a notification to your personal computer or cellular phone, an e-mail address should be set beforehand. For details, access the NissanConnect® Website.	
[Saved locations for unplugged messages]	[Add New]	Touch to add a regularly used charging station to receive unplugged charging connector notification messages.	
	Location list	[Edit Name]	Changes the name of a stored location.
		[Relocate]	Adjusts the location of the stored location.
		[Delete]	Deletes the stored address.
		[OK]	Applies the settings.
[Time delay for unplugged messages]		This confirms the charge connector status at the set checking time. If the charge connector is then disconnected, a notification is sent to the preset e-mail address. Select from [5 min], [10 min], [15 min], [30 min] and [1 hour].	

5. NissanConnect® EV and Services

	[Send unplugged status to Data Center]	With this item turned on, the system recognizes that the charge connector is not connected to the vehicle even though the charge timer function is set, the system transmits this information to the Nissan Data Center. When the Nissan Data Center receives the information, it will send an e-mail to the specified address to inform you of the charge connector status.	
	[Send Charging Status to Data Center]	With this item turned on, if a battery charge is interrupted before it is completed, the system recognizes this and transmits this information to the Nissan Data Center. When the Nissan Data Center receives the information, it will send an e-mail to the specified address to inform you of the battery charge status.	
	[Delete Saved Locations & Reset Message Settings]	Saved locations for charging messages will be deleted and charging messages settings will set to the factory default settings.	
[Auto-Update Stations]		When this item is turned on, new charging station information will be downloaded monthly from the Nissan Data Center, automatically updating the map data.	
[Service Reminders]		The information that is sent from the Nissan Data Center is displayed.	
[Information Feed Setting]	[Download Automatically]	[Select Download Interval]	Select automatic download interval from [Never], [Power on] (downloaded when power is turned on), [Every 30 min], [Every 60 min] and [Every 120 min].
		[Select Information Feed]	Select an information feed from the list to start the automatic download of the feed.
	[Edit Feed List]	[Add to Favorites]	A maximum of 16 favorite feeds selected from the information feeds can be stored in a folder.  "Storing favorites" (page 5-14)
		[Update Feed List]	Connect to the Nissan Data Center and update the information feed list.
		[Initialize Feed List]	Restore the information feed list to the factory default setting.
	[Delete All Information Feed History]	All information feed history will be deleted.	

5. NissanConnect® EV and Services

[Vehicle Information Sharing with Nissan]	[Share Vehicle Information]	When this item is turned on, vehicle information (driving history, etc.) is automatically sent to the Nissan Data Center.
	[Delete Shared Vehicle Information]	Vehicle information (driving history, etc.) is deleted.
[Unit ID Information]		Display the Unit ID, TCU (Telematics Control Unit) ID, SIM ID and VIN Information necessary for user registration.
[Reset all NissanConnect EV/Svcs. settings to default]		All NissanConnect® EV and Services settings are returned to default.
[Vehicle Data Transmission Setting]		When [OK] is touched, data transmission to the Nissan Data Center is enabled. Touch [Decline] to disable the NissanConnect® EV and Services functions.



INFO:

- Notes on [Send unplugged status to Data Center]:
Even if the notification service for the charge connector status is set, no notification is sent and no status can be checked under the following conditions.
 - The system will check the connection status of the charge connector within the period of time set, but will not check once this period of time has been exceeded. Therefore, if the charge connector is removed from the vehicle after the period of time set, a notification is not sent.
 - The charge connector status notification does not indicate the start of battery charging.
 - No notification is sent if the vehicle is outside the communication service area.
 - The notification does not include the reason why the charge connector is disconnected.
 - If the vehicle is not used for 2 weeks, communication with the vehicle is disabled.
 - If the power switch is in the ON position, no notification is sent.
- Notes on [Send Charging Status to Data Center]:
Even if the notification service for the charge completion is set, no notification is sent and no status can be checked under the following conditions.
 - The charge interruption notification does not always indicate the completion of battery charging.

5. NissanConnect® EV and Services

- This notification does not mean that the timer charge function did not start at the time set.
- No notification is sent if the vehicle is outside the communication service area.
- The notification does not include the reason why the battery charging was interrupted.
- If the vehicle is not used for 2 weeks, communication with the vehicle is disabled.
- If the power switch is in the ON position, no notification is sent.

ERROR MESSAGE ON COMMUNICATION

The display may show the following messages on the screen while using the NissanConnect® EV and Services. If the messages are displayed, follow the on-screen instructions. Otherwise, contact a NISSAN certified LEAF dealer.

Error message	Possible solution
System Busy.	The system is busy. Please wait.
No service.	The service is not available in the area. Please try again in an area where connection to the Nissan Data Center is possible.
The connection to the center failed.	Connection to the Nissan Data Center failed. Please try again later.
Telematics communication is currently busy. Please try again later.	The line is busy. Please try again later.

5. NissanConnect® EV and Services

MEMO

6 Viewing information

Information menu	6-2	Apple CarPlay™ system limitations	6-11
SiriusXM Travel Link	6-7	Android Auto™	6-12
Viewing SiriusXM Travel Link.....	6-7	Compatibility	6-12
Apple CarPlay™ (if so equipped)	6-9	Initial Android phone settings	6-12
Compatibility.....	6-9	Android Auto™ operation	6-12
Apple CarPlay™ operation	6-10	Android Auto™ settings	6-14
Apple CarPlay™ settings	6-11	Android Auto™ system limitations	6-14

6. Viewing information

INFORMATION MENU

The information screen sets or displays various information that is helpful for using the vehicle. Available items include the SiriusXM Travel Link information, traffic information, vehicle information, current location information, and navigation software version.

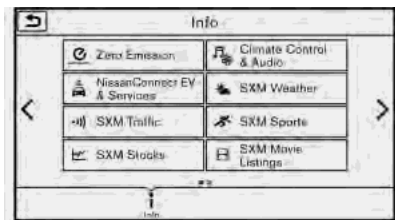

Touch [Info] on the Launch Bar on the screen to display the Information menu.

Menu item	Result
[Zero Emission]	Display the Zero Emission menu screen. ☞ "Zero Emission menu screen" (page 2-2)
[Climate Control & Audio]	Display the climate control information and audio information. ☞ "Displaying climate control & audio screen" (page 1-9)
[NissanConnect EV & Services]	Display the NissanConnect® EV and Services menu screen. ☞ "5. NissanConnect® EV and Services"
[SXM Weather]	[Current Conditions] Display current weather condition information. Touch [Favorite City] to see conditions for a favorite location. To change the favorite location, touch [Change City].
	[5-Day Forecast] Touch [Favorite City] to see the 5-day weather forecast for a selected location. To change the selected location, touch [Change City].





6. Viewing information

Menu item		Result
	[Graphical Map]	Display a graphical map of the weather information on the display. Initially, the system will display all available information. Touch the scale button to show [Zoom In]/[Zoom Out] for changing the map scale to 320 miles (640 km) U.S., 32 miles (64 km) Middle scale or 5 miles (10 km) Detail scale. Touch [Radar] to stop displaying the weather radar map. Touch [Chart] to stop displaying weather surface features and pressure, when the map scale is U.S. Touch [Storm] to stop displaying Storm information, when the map scale is U.S. or Middle scale. Touch [Winds] to stop displaying wind information, when map scale is Detail scale.
	[Alert Map]	Show Alert Map information on the display. Touch [Legend] to display the detailed contents of information used for the current warning/advisory map by type. Touch the scale button to show [Zoom In]/[Zoom Out] for changing the map scale to 320 miles (640 km) U.S., 32 miles (64 km) Middle scale or 5 miles (10 km) Detail scale.
	[Weather Alert]	Turn the weather alert on/off.
[SXM Traffic]	[Info on Route]	Touch to display traffic information detected on the route to the destination.
	[Nearby Traffic Info]	Touch to display traffic information detected near the current vehicle location.
[SXM Sports]		Touch [Yes] to view a list of available sports that can be added or touch [No] to go back. Select a favorite sport and division/conference from the list to view scores. A favorite team cannot be selected. When viewing a favorite, a list of recent and near future games/events is displayed. Touch [Tune] to go to a channel that is broadcasting the event live. A score will also display while the event is broadcasting. Touch [Delete One] to delete a favorite sport or [Delete All] to delete all favorite sports. Up to 10 sports can be saved.

6. Viewing information

Menu item		Result
[SXM Stocks]		To add a favorite stock, touch [Yes] to display a List of Matching Stocks. Select a stock by performing a search or typing in the symbol. Touch [Yes] to add a stock to the list or touch [No] to go back. Touching [Add Stock] will also allow adding a favorite stock. Once a stock is added, it's price, trend, and date can be viewed. Red indicates the stock is down and green indicates the stock is up. Touch [Delete Stock] to [Delete All] or [Delete One]. Up to 20 stocks can be saved. Only supported stocks can be added.
[SXM Movie Listings]	[Nearby Theaters]	Displays a list of theaters by distance. Select the theater for Theater Details such as its location and phone number. While viewing the Theater Details, touch [Go here] for route guidance. While viewing the list of Nearby Theaters, touch [Movies] to display a list of movies that are playing at that theater. Select the movie to display Movie Details including the rating, running time, and show times.
	[Current Movies]	Displays a list of movies that are currently playing. Touch [Details] to display Movie Details including the rating, running time, and show times. While viewing the list of Current Movies, select the movie to display a list of Nearby Theaters. Select the theater for Theater Details such as its location and phone number. Touch [Movies] for a detailed description and show times of the selected movie. Touch [Go Here] for route guidance to the selected theater.
[Vehicle]	[Energy Usage]	Estimated driving range and energy usage of various systems are displayed.  "Viewing energy usage information" (page 2-8)

6. Viewing information

Menu item		Result
[Charging Station Info]	[Near Current Location]	Location information about the charging stations around the selected area can be checked. Touch the preferred charging station from the list. Touch [Show Map] to display the selected charging station and to set it as a destination. Touch [Call] to make a call to the charging station. Touch [Details] to display detail information such as the type and number of charging devices at the charging station. Touch [Options] to select option items.  "Finding charging station" (page 3-19)
	[Near Destination]	
	[Near Scroll Position]	
	[Near City Center]	
	[Near Another POI]	
[Where am I?]		The name and distance of the next/previous street, and other information that indicates the current vehicle location are displayed. GPS coordinates and altitude are shown on the bottom right.
[SXM Weather Alerts]		Display the list of weather alerts. Touch [Nearby Current] to display nearby current alerts, touch [Nearby Destination] to display nearby destination alerts.
[Navigation Version]		Displays the information of the current map version, program version, unit code, etc.
[GPS Position]		Displays GPS information, such as number of satellites, latitude/longitude, and approximate altitude.
[Apple CarPlay] (if so equipped)		Displays the Apple CarPlay™ screen.  "Apple CarPlay™" (page 6-9)
[Nissan's Help for Apple CarPlay] (if so equipped)		Displays tips for Apple CarPlay™ operation.  "Apple CarPlay™" (page 6-9)
[Android Auto]		Displays the Android Auto™ screen.  "Android Auto™" (page 6-12)
[Nissan's Help for Android Auto]		Displays tips for Android Auto™ operation.  "Android Auto™" (page 6-12)

6. Viewing information



A SiriusXM Travel Link or SiriusXM Traffic subscription is necessary to receive SiriusXM information services.

SiriusXM TRAVEL LINK

SiriusXM Travel Link information is a subscription service offered by SiriusXM Satellite Radio. It is necessary to subscribe to use the SiriusXM Travel Link information.

This service provides real-time information regarding current weather, fuel prices, sports scores, stock tickers and movie times where available. The SiriusXM Travel Link is broadcast to the vehicle by SiriusXM Satellite Radio.

The service enables you to view the following information on the navigation system:

*Current information around the destination

*Detailed information and forecasts of an area of interest

*Countrywide and local maps with the current weather, temperature, warnings and road condition information

*List of warning/watches events detected around the current location

*Pop-up messages on the navigation screen with voice announcements when warnings and watches are detected around the current location

SXM service menus can be accessed from the information screen.

 "Information menu" (page 6-2)



WARNING

SiriusXM Travel Link information is not a substitute for attentive driving. Weather conditions change constantly and emergency situations can arise without warning. Relying only on SiriusXM Travel Link information could result in serious personal injury.

VIEWING SIRIUSXM TRAVEL LINK

SiriusXM Satellite Radio and SiriusXM Travel Link subscriptions are sold separately or as a package, and are continuous until you call SiriusXM to cancel. See SiriusXM Customer Agreement for complete terms at www.siriusxm.com (for U.S.) or www.siriusxm.ca (for Canada). SiriusXM Travel Link is available in select markets.

For more information, refer to the SiriusXM website or call Listener Care.

SiriusXM website:

For U.S.

www.siriusxm.com/travellink

For Canada

www.siriusxm.ca/siriusxm-traffic-

services/siriusxm-travel-link (English)
www.siriusxm.ca/fr/services-siriusxm-traffic/siriusxm-travel-link (French)

Listener Care:

For U.S.

1-877-447-0011

For Canada

1-877-438-9677



INFO:

- If a contract is not completed for the SiriusXM Travel Link information service, a message appears and it will not be possible to check the information on the traffic information system.

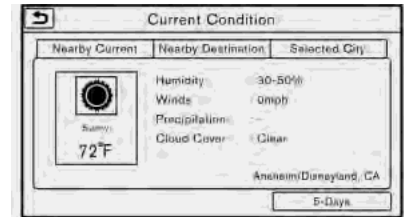

Example

- The weather information is available only for areas that provide weather information to SiriusXM Travel Link.

6. Viewing information

- Not all vehicles or devices are capable of receiving all services offered by SiriusXM. Data displays and individual product availability vary by vehicle hardware. Current information and features may not be available in all locations, or on all receivers. SiriusXM is not responsible for any errors or inaccuracies in the data services or their use in the vehicle.

Notes on SiriusXM Traffic information

- The SiriusXM Traffic information service is not provided for some cities. In addition, the cities for which the traffic information service is provided may be changed.
- In some cases, infrastructure problems may prevent the complete display of the traffic information. This is not a malfunction.
- Due to infrastructure problems, or due to the time when the traffic information service broadcast is received, the displayed information may differ from the actual traffic conditions.
- Depending on the traffic information, a detour route may be slower than the original route.

- SiriusXM Satellite Radio and SiriusXM Traffic subscriptions are sold separately or as a package, and are continuous until you call SiriusXM to cancel. See SiriusXM Customer Agreement for complete terms at the SiriusXM website.

SiriusXM website:

For U.S.

www.siriusxm.com

For Canada

www.siriusxm.ca (English)

www.siriusxm.ca/fr (French)

SiriusXM Traffic is available in select markets. For more information, refer to the SiriusXM website or call Listener Care.

SiriusXM website:

For U.S.

www.siriusxm.com/traffic

For Canada

www.siriusxm.ca/siriusxm-traffic-services/siriusxm-travel-link (English)

www.siriusxm.ca/fr/services-siriusxm-traffic/siriusxm-travel-link (French)

Listener Care:

For U.S.

1-877-447-0011

For Canada

1-877-438-9677

- SiriusXM Traffic is available in over 130 metropolitan markets. For the most current list of markets covered, please refer to the SiriusXM website or call Listener Care.

SiriusXM website:

For U.S.

www.siriusxm.com/siriusxmtraffic

For Canada

www.siriusxm.ca/siriusxm-traffic-services/siriusxm-traffic (English)

www.siriusxm.ca/fr/services-siriusxm-traffic/siriusxm-traffic (French)

Listener Care:

For U.S.

1-877-447-0011

For Canada

1-877-438-9677

- Due to road maintenance, infrastructure problems (e.g. malfunction of road sensors, outage of central com-

puter of infrastructure) or natural disasters, there are times when some or all traffic information may not be available.

- Incident information is based on human collection. Not all incidents that have happened are collected and provided.
- Due to infrastructure problems, or transmission delay, there are times when the information may differ from the actual condition. Always observe safe driving practices and follow all traffic regulations.
- Due to the coverage and quality of traffic information and road conditions, it is not always possible for the system to provide the shortest time route even when traffic information is considered.
- Traffic information that is displayed may differ from information from other media (e.g., radio), as other media may use different information sources.

Apple CarPlay™ (if so equipped)



WARNING

- **Stop your vehicle in a safe location and apply the parking brake before connecting your iPhone® to the vehicle or operating your connected iPhone® for setup.**
- **If you are unable to devote full attention to vehicle operation while using Apple CarPlay™, pull off the road to a safe location and stop your vehicle.**

You can use Apple CarPlay™ by connecting a compatible iPhone® to your vehicle via a USB cable.

With Apple CarPlay™, your in-vehicle system can be used as a display and a controller for some of the iPhone® functions. The Apple CarPlay™ features Siri® which enables operations via voice controls. Visit Apple.com for information about the functions that are available and details about Apple's privacy policy.

Certain vehicle information (e.g. location and speed) may be shared with your device while Apple CarPlay™ is in use.

Carrier charges may apply to use Apple CarPlay™.

COMPATIBILITY

Only iPhone® 5 or later models and iOS 8.3 or later versions are compatible with Apple CarPlay™.

Refer to the Apple website for more information.







INFO:

- For best results, always update your device to the latest software version.
- Apple CarPlay™ will take the place of your Bluetooth® audio and Bluetooth® Hands-Free Phone functionality.
- Phone menu and access to the connected phone through Voice Recognition System will be disabled while Apple CarPlay™ is connected. To access your phone, use the Siri® function or select the phone icon on the Apple CarPlay™ top menu screen.

6. Viewing information

Apple CarPlay™ OPERATION

1. Connect the iPhone® to USB connection port.
 "USB (Universal Serial Bus) Connection Port and AUX (auxiliary) input jack" (page 1-5)
2. Depending on the setting, a Startup Information screen will appear. Touch [Yes] to use Apple CarPlay™.
 **INFO:**
If you do not wish to display the Startup Information screen each time you activate Apple CarPlay™, touch [Don't show again] on the Startup Information screen. The Startup Information screen will not be displayed from the next Apple CarPlay™ activation. The Startup Information screen can be set to appear again in the Apple CarPlay™ setting menu.
 "Apple CarPlay™ settings" (page 6-11)
3. The Apple CarPlay™ screen will appear. The iPhone® functions displayed on the screen should now be operable using the in-vehicle system.
4. To return to the Apple CarPlay™ top menu screen after operation, touch  on the lower corner of the Apple

CarPlay™ screen.

5. To exit the Apple CarPlay™ screen and display the other screens, push **<MENU>** or the other buttons on the control panel and touch the desired menu.
6. To return to the Apple CarPlay™ screen, touch [Info] on the Launch Bar and then touch [Apple CarPlay]. The Apple CarPlay™ screen can also be displayed by touching [Apple CarPlay] after touching [MENU] on the Launch Bar or after pushing **<MENU>**.

INFO:

When your iPhone® is locked with a passcode, Apple CarPlay™ can still be activated by operating the iPhone® and allowing Apple CarPlay™ activation when asked.

Siri® operation



With Siri®, some of the functions in your iPhone® can be voice controlled when Apple CarPlay™ is active.

Activation:

There are three ways to start a Siri® session.

- Push and hold **< >** on the steering wheel.
- Touch and hold  on the lower corner of the Apple CarPlay™ screen.
- Say "Hey Siri" (requires "Allow "Hey Siri" activation on the iPhone®).

INFO:

- Push **< >** or touch  to end Siri® operation.
- Keep the interior of the vehicle as quiet as possible. Close the windows to eliminate the surrounding noises (traffic noises, vibration sounds, etc.), which may prevent the system from recognizing the voice commands correctly.
- For functions that can be used with Siri®, please refer to the Apple website.
- The volume level of Siri® can be adjusted.
 "Volume and Beeps settings" (page 1-17)

Phone operation

If you wish to make a call with Apple CarPlay™, follow the procedure below:

1. Touch [Phone] on the Launch Bar.
2. Operate the screen displayed to make a call, etc.

Apple CarPlay™ SETTINGS

1. Touch [Settings] on the Launch Bar.
2. Touch [Apple CarPlay Settings].

Available items:

- [Always Start Apple CarPlay]:
When this item is turned on, Apple CarPlay™ will activate automatically when the iPhone® is connected to USB connection port.
- [Nissan's Help for Apple CarPlay]:
Displays tips for Apple CarPlay™ operation.
- [Show Startup Information]:
Allows you to set whether or not to show the Apple CarPlay™ Startup Information screen upon each iPhone® connection.
Touch [No] if you do not wish to show the Startup Information screen each time the iPhone® is connected to USB connection port.
Touch [Yes] to show the Startup Information screen upon each connection of your iPhone® to USB connection port.

This setting item will be grayed out until you touch [Don't show again] on the Startup Information screen to turn the setting on.



INFO:

- [Nissan's Help for Apple CarPlay] can also be accessed from the Information menu.
 "Information menu" (page 6-2)
- Phone menu and access to the connected phone through voice recognition system will be disabled while Apple CarPlay™ is connected. To access your phone, use the Siri® function or select the phone icon in the Apple CarPlay™ top menu screen.
- Normal voice recognition access to songs on your iPod® music will not be available when connected to Apple CarPlay™. To access your iPod® music, use the Siri® function or select the music icon in the Apple CarPlay™ top menu screen.

Apple CarPlay™ SYSTEM LIMITATIONS

For all features of Apple CarPlay™ to operate correctly, it is necessary to have a compatible iPhone®, a cellular connection and a data plan.

When Apple CarPlay™ is operating, system performance is affected by the strength of the cellular connection or performance of the phone itself. If performance of the system decreases:

- Disconnect and reconnect your phone
- Close all apps and restart them
- Cycle phone power off/on to restart

It is also recommended to use the Apple Lightning™ cable (Mfi certified) that was provided with your phone and confirm the latest software version is installed.

Functionality of Apple CarPlay™ may decrease or be lost if there are changes to operating systems, hardware, software or other technologies central to supporting the system that are outside of NISSAN's control. Changing government regulations may also affect operation of Apple CarPlay™.

6. Viewing information

Android Auto™



WARNING

- **Stop your vehicle in a safe location and apply the parking brake before connecting your Android phone to the vehicle or operating your connected Android phone for setup.**
- **If you are unable to devote full attention to vehicle operation while using Android Auto™, pull off the road to a safe location and stop your vehicle.**

You can use Android Auto™ by connecting a compatible Android phone to your vehicle via a USB cable. It is also recommended to use the Android phone OEM cable that was provided with your phone. With Android Auto™, your in-vehicle system can be used as a display and a controller for some of the Android phone functions. Voice control of some of the Android phone functions is also possible with Android Auto™. Visit www.android.com for information about the functions that are available and details about Google's privacy policy.

Certain vehicle information (e.g. location and speed) may be shared with your device while Android Auto™ is in use. Carrier charges may apply to use Android Auto™.

COMPATIBILITY

Only Android 5.0 (Lollipop) or later versions are compatible with Android Auto™.

Refer to the Android Auto™ website for more information.



INFO:

- Download the Android Auto™ application from Google Play to Android phone in advance.
- For best results, always update your device to the latest Android software and Android Auto™ app version. When you connect the Android phone to the in-vehicle system, it will automatically update Android software and Android Auto™ app version.
- Android Auto™ will take the place of your Bluetooth® audio and Bluetooth® Hands-Free Phone functionality.
- If you set a destination with navigation applications on your Android phone while Android Auto™ is active, the route setting of the in-vehicle navigation

system will be canceled.

INITIAL ANDROID PHONE SETTINGS

Before using Android Auto™, Android Auto™ app must be downloaded on your Android phone.

For downloading the Android Auto™ app, refer to the Google Play on website.

Android Auto™ OPERATION

Unlock your phone's screen before connecting your Android phone.

1. Connect your Android phone to a USB connection port.
 -  "USB (Universal Serial Bus) Connection Port and AUX (auxiliary) input jack" (page 1-5)
2. Depending on the setting, a Startup Information screen will appear on the touch screen display. Touch [Yes] to use Android Auto™.



INFO:

- If you do not wish to display the Startup Information screen each time you activate Android Auto™, touch [Don't ask anymore] on the Startup Information screen. The Startup Information screen will not

be displayed from the next Android Auto™ activation. The Startup Information screen can be set to appear again in the Android Auto™ setting menu.

 "Android Auto™ settings" (page 6-14)

- Bluetooth® will turn on automatically when Android Auto™ is connected to the vehicle.
- 3. The Android Auto™ screen will appear. The Android phone functions displayed on the screen should now be operable using the in-vehicle system.
- 4. To return to the Android Auto™ top menu screen after operation, touch  on the lower corner of the Android Auto™ screen.
- 5. To exit the Android Auto™ screen and display the other screens, push **<MENU>** or the other buttons on the control panel and touch the desired menus.
- 6. To return to the Android Auto™ screen, touch [Info] on the Launch Bar and then touch [Android Auto]. The Android Auto™ screen can also be displayed by touching [Android Auto] after touching [MENU] on the Launch Bar or after pushing **<MENU>**.



INFO:



- While the Android Auto™ is activated on the Android phone, the phone operations such as making or receiving calls can only be done with Android Auto™.
- When an Android phone is connected to the USB connection port, the Bluetooth® function turns on automatically. Keep the Bluetooth® turned on to use the phone functions.
- Depending on the device, an Android phone requires MTP mode to be selected in the USB transfer setting.

Operating with voice

Some of the functions in your Android phone can be voice controlled when Android Auto™ is active.

Activation:



There are three ways to start a voice operation session.

- Push and hold  on the steering wheel.
- Touch  at the upper right corner of the Android Auto™ screen.

- Say "OK Google" (requires the appropriate setting on the Android phone).



INFO:

- Push  or touch  to end voice operation.
- Keep the interior of the vehicle as quiet as possible. Close the windows to eliminate the surrounding noises (traffic noises, vibration sounds, etc.), which may prevent the system from recognizing the voice commands correctly.
- For functions that can be used with the voice operation, refer to the Android Auto™ website.
- The volume level of voice operation can be adjusted.
 "Volume and Beeps settings" (page 1-17)

Phone operation

If you wish to use your phone while Android Auto™ is activated, follow the procedure below:

1. Touch [Phone] on the Launch Bar.
2. Operate the screen displayed to make a call, etc.

6. Viewing information

Android Auto™ SETTINGS

1. Touch [Settings] on the Launch Bar.
2. Touch [Android Auto Settings].

Available items:

- [Always Start Android Auto]:
When this item is turned on, Android Auto™ will activate automatically when the Android phone is connected to the USB connection port.
- [Show Startup Information]:
Allows you to set whether or not to show the Android Auto™ Startup Information screen upon each Android phone connection.
Touch [No] if you do not wish to show the Startup Information screen each time the Android phone is connected to USB connection port.
Touch [Yes] to show the Startup Information screen upon each connection of your Android phone to USB connection port.
This setting item will be grayed out until you touch [Don't ask anymore] on the Startup Information screen to turn the setting on.
- [Nissan's Help for Android Auto]:
Displays helpful tips for Android Auto™ operation.



INFO:

- [Nissan's Help for Android Auto] can also be accessed from the Information menu.
- For restrictions on using Android Auto™, refer to [Nissan's Help for Android Auto].
- The Phone menu of the in-vehicle system and access to the connected phone through the Voice Recognition System will be disabled while Android Auto™ is connected. To access your phone, use the voice operation function or touch [Phone] on the Launch Bar on the Android Auto™ top menu screen.

Android Auto™ SYSTEM LIMITATIONS

For all features of Android Auto™ to operate correctly, it is necessary to have a compatible Android phone, a cellular connection and a data plan. When Android Auto™ is operating, system performance is affected by the strength of the cellular connection or performance of the phone itself. If performance of the system decreases:

- Disconnect and reconnect your phone

- Close all apps and restart them

- Cycle phone power off/on to restart

It should also be confirmed that the latest version of both Android OS and Android Auto™ application are installed on the cellular phone.

Functionality of Android Auto™ may decrease or be lost if there are changes to operating systems, hardware, software or other technologies central to supporting the system that are outside of NISSAN's control. Changing government regulations may also affect operation of Android Auto™.

7 Hands-Free Phone

Bluetooth® Hands-Free Phone System	7-2
Indicators	7-3
Phone	7-4

Hands-free text messaging assistant	7-6
Phone and text message assistant settings	7-10
Bluetooth® setting	7-13



7. Hands-Free Phone

BLUETOOTH® HANDS-FREE PHONE SYSTEM



WARNING

- Use a phone after stopping your vehicle in a safe location. If you have to use a phone while driving, exercise extreme caution at all times so full attention may be given to vehicle operation.
- If you find yourself unable to devote full attention to vehicle operation while talking on the phone, pull off the road to a safe location and stop your vehicle before doing so.



CAUTION

To avoid draining the vehicle battery, use a phone after the READY to drive indicator light is ON.

Your vehicle is equipped with Bluetooth® Hands-Free Phone System. If you are an owner of a compatible Bluetooth® enabled cellular phone, you can set up the wireless connection between your cellular

phone and the in-vehicle phone module. With Bluetooth® wireless technology, you can make or receive a telephone call with your cellular phone in your pocket.

Once a cellular phone is connected to the in-vehicle phone module, the procedure for connecting the phone does not need to be performed again. Your phone is automatically selected with the in-vehicle phone module when the power switch is pushed to the ON position with the selected cellular phone turned on and carried in the vehicle.

You can register up to 5 different Bluetooth® devices in the in-vehicle phone module. However, you can talk on only one cellular phone at a time.

The Voice Recognition system supports phone commands, so dialing a phone number using your voice is possible.

 "8. Voice recognition"

Before using the Bluetooth® Hands-Free Phone System, refer to the following notes.

- Wireless LAN (Wi-Fi) and the Bluetooth® functions share the same frequency band (2.4 GHz). Using the Bluetooth® and the wireless LAN functions at the same time may slow down or disconnect the communication and cause undesired noise. It is recom-

mended that you turn off the wireless LAN (Wi-Fi) when using the Bluetooth® functions.

- Set up the wireless connection between a compatible cellular phone and the in-vehicle phone module before using the Bluetooth® Hands-Free Phone System.
- Some Bluetooth® enabled cellular phones may not be recognized by the in-vehicle phone module. Visit the website below for a recommended phone list.
www.nissanusa.com/bluetooth/
- You will not be able to use a hands-free phone under the following conditions:
 - Your vehicle is outside of the telephone service area.
 - Your vehicle is in an area where it is difficult to receive radio waves; such as in a tunnel, in an underground parking garage, behind a tall building or in a mountainous area.
 - Your cellular phone is locked in order to prevent dialing.
- When the radio wave condition is not ideal or ambient sound is too loud, it may be difficult to hear the other

person's voice during a call.

- Immediately after the power switch is pushed to the ON position, it may be impossible to receive a call for a short period of time.
- Do not place the cellular phone in an area surrounded by metal or far away from the in-vehicle phone module to prevent tone quality degradation and wireless connection disruption.
- While a cellular phone is connected through the Bluetooth® wireless connection, the battery power of the cellular phone may discharge quicker than usual.
- Visit the website below for troubleshooting help if the Bluetooth® Hands-Free Phone System seems to be malfunctioning.
www.nissanusa.com/bluetooth/
- Some cellular phones or other devices may cause interference or a buzzing noise to come from the audio system speakers. Storing the device in a different location may reduce or eliminate the noise.
- Refer to the cellular phone Owner's Manual regarding the telephone pairing procedure specific to your phone,



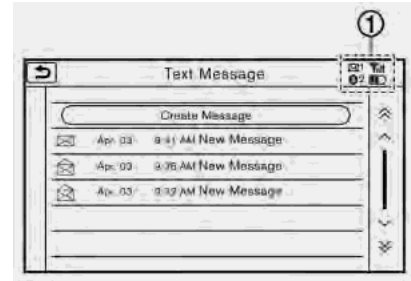

battery charging, cellular phone antenna, etc.

- The antenna display on the monitor may not coincide with the antenna display of some cellular phones.
- The battery display on the monitor may not coincide with the battery display of some cellular phones.
- Keep the interior of the vehicle as quiet as possible to hear the caller's voice clearly as well as to minimize its echoes.
- If reception between callers is unclear, adjusting the incoming or outgoing call volume may improve the clarity.
- The microphone is located near the map light.
- Some of the hands-free phone operations are also available on the vehicle information display.

INDICATORS



Indicators ① for phone and text messaging are displayed on the top of the screen.

 1	Indicates the number of unread received messages.
 2	Indicates the Bluetooth® device that is selected.
	Indicates the strength of the signal the Bluetooth® device is receiving.
	Indicates the amount of remaining Bluetooth® device battery.

7. Hands-Free Phone

PHONE

Connecting Bluetooth® Hands-free Phone

A cellular phone device must be connected to the Bluetooth® Hands-free phone system before operation. Up to 5 Bluetooth® devices can be connected to the system.

 "Connecting Bluetooth® device" (page 1-18)

Phone selection

Select one of the connected devices for operation.

1. Touch [Phone] on the Launch Bar.
2. Touch [Select BT Device]. A list of the connected cellular phones is displayed.
3. Touch one of the connected cellular phones from the list.
4. Touch [Connect].



INFO:

Touch [Edit] to change the device name. Touch [Delete] to delete the device from the device list.

5. When the device selection is successful, a message on the touch screen

display indicates that the cellular phone was selected.



INFO:

To select a phone, Bluetooth® of the phone device needs to be turned on.

Making a call

1. Touch [Phone] on the Launch Bar.
2. Select one of the following methods to make a call.

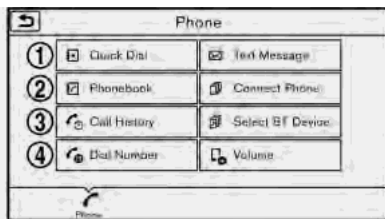

①[Quick Dial] :

Select a telephone number from a list of personally selected numbers.

 "Quick Dial" (page 7-12)

②[Phonebook] :

Select a person and the phone number you wish to call from the phonebook.

Depending on the device, the phone-

book will be downloaded from the cellular phone automatically when it is connected. If the automatic download does not take place, the telephone number must be transferred to the hands-free phone system from the cellular phone prior to using this method.

 "Phone settings" (page 7-10)

③[Call History] :

Select a telephone number from recent incoming, outgoing or missed calls.

④[Dial Number] :

Enter the phone number manually using the keypad displayed on the screen and touch [OK].

 "How to input letters and numbers" (page 1-11)

3. Dialing will start and the screen will change to the call in progress screen.

7. Hands-Free Phone

Receiving a call

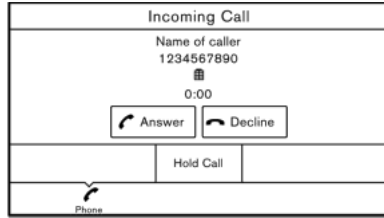

When you receive a phone call, a notification message is displayed on the touch screen display with a ring tone.

Taking a call:

To answer the call, take one of the following actions.

- Push <  > on the steering wheel.
- Touch [Answer].

Rejecting a call:

To reject the call, touch [Decline].

Holding a call:

To hold the call, touch [Hold Call].

During a call

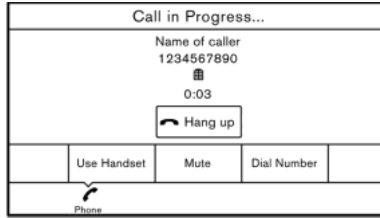

The screen as illustrated will appear during a call.

To hang up the phone, touch [Hang up].

Call from a second person:

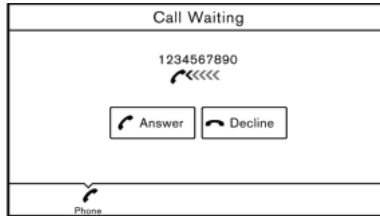

When another phone call is received during a call, the screen as illustrated will appear.

Rejecting call from a second person:

To reject a call from the second person and continue the conversation with the

first caller, touch [Decline].

Answering call from a second person:

To answer the call from the second person and place the first caller on hold, take one of the following actions.

- Push <  > on the steering wheel.
- Touch [Answer].

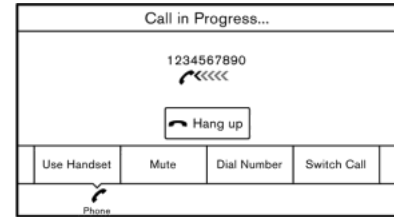

The screen as illustrated will appear during a call with a second person.

To hang up the phone and return to the conversation with the first caller, touch [Hang up].

To switch between two calls on line, touch [Switch Call].

Operations during a call:

There are some options available other than hanging up a call or answering/rejecting incoming calls.

Touch one of the following displayed keys

7. Hands-Free Phone

on the screen to take action.

Available item	Action
[Use Handset]	Transfer the call to the cellular phone.
[Mute]/[Cancel Mute]	When muted, your voice will not be heard by the person on the other end of the line.
[Dial Number]	Using the touch tone, send digits to the connected party for using services such as voicemail.
[Switch Call]*	Answer another incoming call. The person you are talking to will be placed on hold. Push once more to speak to the person on hold again.

*: Available when a call is received while on the line with another person. The availability of this function depends on the phone device.



INFO:

To adjust the person's voice to be louder or quieter, turn **<VOL/  >** on the control panel or push **< + >/< - >** on the steering wheel, while talking on the phone.

HANDS-FREE TEXT MESSAGING ASSISTANT



WARNING

- **Use the text messaging feature after parking your vehicle in a safe location. If you have to use the feature while driving, exercise extreme caution at all times so full attention may be given to vehicle operation.**
- **Laws in some jurisdictions may restrict the use of "Text-to-Speech." Check local regulations before using this feature.**
- **Laws in some jurisdictions may restrict the use of some of the applications and features, such as social networking and texting. Check local regulations for any requirements.**
- **If you are unable to devote full attention to vehicle operation while using the text messaging**

feature, pull off the road to a safe location and stop your vehicle.



NOTE:

This feature is disabled if the connected device does not support it. See the cellular phone Owner's Manual for details and instructions.

The system allows for the sending and receiving of text messages through the vehicle interface.

Receiving a message

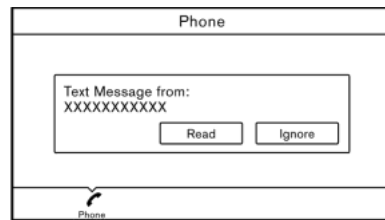

When the cellular phone connected to the vehicle receives a text message, a notification will appear on the touch screen display with a tone.

To check the message, touch [Read]. Touch [Ignore] to save the message to be checked later.

Before using the text messaging assistant

feature, confirm the settings of the iPhone®.

1. Connect your iPhone® to the Bluetooth® Hands-Free Phone System.
2. Disconnect iPhone® from the Bluetooth® settings menu.
☞ “Bluetooth® setting” (page 7-13)
3. Turn “Show Notification” ON from the Bluetooth® setting menu on your iPhone®.
4. Place the power switch in the OFF position, and then place the power switch in the ACC or ON position after waiting approximately 3 minutes.

INFO:

Depending on the phone device, notification display setting needs to be turned on on the phone device.

Displaying received message list

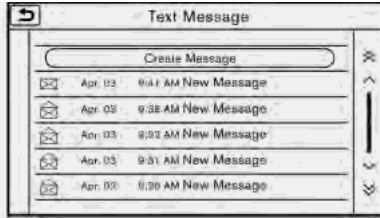

1. Touch [Phone] on the Launch Bar.
2. Touch [Text Message].
3. Touch an item on the list to read or reply to the message.

INFO:

Up to 20 messages can be stored in the message list.

Received message screen

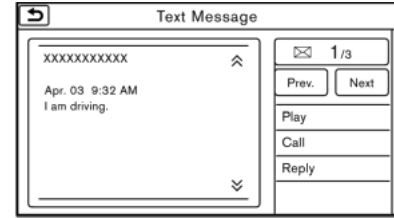

Touching [Read] on the new message notification screen or selecting a message from the message list will show the details of the received message on the display.

Available actions:

- [Prev.]:
Touch to read the previous message.
- [Next]:
Touch to read the next message.
- [Play]/[Stop]:
Touch [Play] to have the hands-free phone system read out the received message. Touch [Stop] to stop reading.
- [Call]:
If the sender of the message is registered in the Phonebook, touch this icon to make a call to the sender.

7. Hands-Free Phone

- [Reply]:
A reply message can be selected from the template.
☞ “Sending a text message”
(page 7-8)
- [Exit]:
Touch to exit the text messaging screen.

INFO:

- Available keys may vary depending on the situations.
- If the sender's name and phone number is registered in the Phonebook, the name of the sender is displayed when a message is received.
- The volume of the voice for text message reading can be adjusted.
☞ “Volume and Beeps settings”
(page 1-17)

Sending a text message

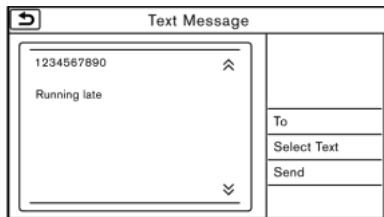

1. Touch [Phone] on the Launch Bar.
2. Touch [Text Message].
3. Touch [Create Message].

7. Hands-Free Phone

The following items are available.

Available item		Action
[To]	[Quick Dial]	Select a recipient from Quick Dial.
	[Phonebook]	Select a contact from the Phonebook.
	[Call History]	Select a contact/phone number from call history.
	[Enter Number by Keypad]	Enter the phone number of the recipient using the keypad. Touch [OK] to confirm the address.
[Select Text]	[Fixed Text]	Touch to display a list of pre-defined text messages.
	[Custom Text]	Touch to display a list of custom text message templates. Custom text can be created or edited from the setting menu.  "Phone and text message assistant settings" (page 7-10)
[Send]		Touch to send the message.

7. Hands-Free Phone

PHONE AND TEXT MESSAGE ASSISTANT SETTINGS

Phone settings

Hands-Free Phone System settings can be changed according to the user's preference.

1. Touch [Settings] on the Launch Bar.
2. Touch [Phone].

The following phone setting items are available.

Setting item		Action
[Quick Dial]	[Edit]	Entries in the Quick Dial can be edited. Touch [Add New] to register a new entry.
	[Delete All]	Deletes all of the phone number in the Quick Dial.
[Call History]	[Incoming]	Items in the calls history can be deleted or be registered in the Quick Dial.
	[Outgoing]	
	[Missed]	
[Phonebook]	[Download Entire Phonebook]	All of the phone numbers that are stored in a phonebook of a cellular phone that is connected to the vehicle are downloaded at once.
	[Download 1 Entry]	Each of the phone numbers that are stored in the phonebook of a cellular phone that is connected to the vehicle is downloaded one by one.
	[Downloaded List]	The downloaded phonebook data is displayed. The items on the list can be added to the Quick Dial entries or be deleted from the phonebook.

7. Hands-Free Phone

[Text Message]	[Text Message]	Turns the message function on/off.
	[Text Message Ringtone]	Turns the incoming message sound on/off.
	[Signature]	Turns the signature setting for the outgoing text message on/off.
	[Auto Reply]	Turns the automatic reply of fixed messages on/off.
	[Auto Reply Text Message]	Selects and sets an automatic reply message.
	[Sending Retry Count]	Sets the number of retries after failing to send a text message.
	[Edit Custom Text]	Edits the custom text.
[Volume]	[Ringtone]	Adjust the volume level of the ringtone by touching [+] or [-].
	[Incoming Call]	Adjust the incoming call volume by touching [+] or [-].
	[Outgoing Call]	Adjust the outgoing call volume by touching [+] or [-].
	[Automatic Hold]	When this function is activated, an incoming phone call will be put on hold automatically.
	[Vehicle Ringtone]	When this function is activated, a specific ringtone that is different from that of the cellular phone will sound when receiving a call.
[Auto Downloaded]	Turns the automatic download on/off.	



INFO:

The phone volume can also be changed by touching [Phone] on the Launch Bar and then touching [Volume].

7. Hands-Free Phone

Phonebook

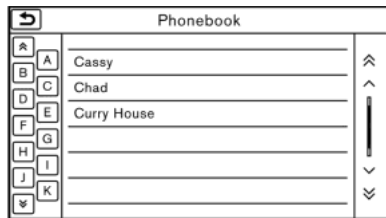

Phonebook information in cellular phones can be downloaded to be used for making calls and sending text messages.

"Phone settings" (page 7-10)

Quick Dial

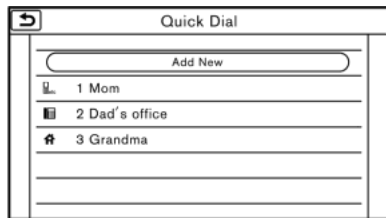

Up to 5 Quick Dial entries can be registered.

Quick Dial entries can be used to make a call or to send text messages.

Registration:

1. Touch [Phone] on the Launch Bar.
2. Touch [Quick Dial].
3. Touch [Add New] to register a phone number to the Quick Dial list.
4. Select a method for registration.

Available methods:

- [Copy from Call History]:
A phone number can be selected from [Incoming], [Outgoing], or [Missed] call history lists.
- [Copy from Phonebook]:
A phone number can be selected from the Phonebook.
- [Enter Number by Keypad]:
A phone number can be entered manually using keypad.



INFO:

Available methods may vary depending on conditions.

5. The registration screen is displayed. Enter and edit the entry information as necessary.
6. Touch [OK] to save the entry.



INFO:

Quick Dial entries can also be registered by touching [Settings] on the Launch Bar and then selecting [Phone].

"Phone settings" (page 7-10)

Voice Tag:

A custom voice tag can be recorded for each of the items registered in the Quick Dial and be used to dial the number by speaking it.

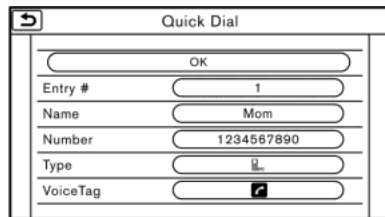

On the Quick Dial registration screen, select [VoiceTag].

Available Items	Action
[Play]	Play the recorded voice tag.
[Store]	Touch to record a voice tag for the phone number.
[Restore]	Touch to rerecord the voice tag.
[Delete]	Touch to delete the voice tag.

BLUETOOTH® SETTING

The Bluetooth® setting can be changed.

1. Touch [Settings] on the Launch Bar.
2. Touch [Bluetooth].

Available item	Action	
[Bluetooth]	If this setting is turned off, the connection between the Bluetooth® devices and the in-vehicle Bluetooth® module will be canceled.	
[Connect Device]	Connects to the Bluetooth® device. Up to 5 devices can be registered.	
[Select BT Device]	[Phone]	Registered devices are shown on the list. Select a Bluetooth® device from the list.
	[Audio Player]	Information of the selected device can be edited and the device can also be deleted from the device list.
[Edit Bluetooth Information]	[OK]	Touch to apply the changes after editing the Bluetooth® information.
	[PIN]	PIN code can be checked and changed.
	[Device Name]	Device Name can be checked and changed.
	[Device Address]	Device Address can be checked.

7. Hands-Free Phone

MEMO

8 Voice recognition

Voice recognition	8-2
Using Voice Recognition System	8-2
Before starting	8-2

Giving voice commands	8-2
Voice recognition settings	8-19



8. Voice recognition

VOICE RECOGNITION

USING VOICE RECOGNITION SYSTEM

Initialization

When the power switch is pushed to the ON position, Voice Recognition is initialized. When the initialization is complete, the system is ready to accept voice commands. If  on the steering wheel is pushed before the initialization completes, the display will show a message to wait until the system is ready.

BEFORE STARTING

To get the best recognition performance from Voice Recognition, observe the following items.

- The interior of the vehicle should be as quiet as possible. Close the windows to eliminate the surrounding noises (traffic noise, vibration sounds, etc.), which may prevent the system from correctly recognizing the voice commands.
- Wait until the tone sounds before speaking a command.
- Speak in a natural conversational voice without pausing between words.

- The system cannot recognize voice commands spoken from passenger seats.

GIVING VOICE COMMANDS

1. Push  located on the steering wheel.

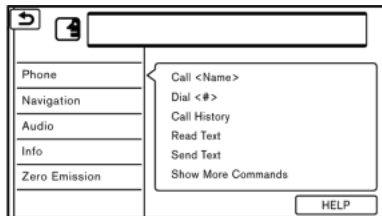

2. A list of commands appears on the screen, and the system provides the voice menu prompt.

Available category commands are displayed on the left side of the screen. Speak or touch a category command from the category command list.







INFO:

- Some of the commands for each category are shown on the right side of the screen and they can also be spoken without selecting a category.

- After executing the category command, only the commands related to the selected category can be recognized.

 "Command list" (page 8-6)

3. After the tone sounds and the icon on the screen changes from  to , speak a command. You can also select a command by directly touching the screen or by pushing / and pushing **<OK>** on the steering wheel.



INFO:

The Voice Recognition system will pause its operation when no command is given after three prompts. To resume the operation, push  on the steering wheel.

4. Continue to follow the voice menu prompts and speak the voice commands after the tone sounds until the preferred operation is executed.



INFO:

To cancel a voice command, push and hold  on the steering wheel.

Operating tips

- Speak a command after the tone.
- If the command is not recognized, the system will prompt you to speak the command again. Repeat the command in a clear voice.
- Touch [↩] on the touch screen to return to the previous screen.
- To exit the Voice Recognition system, push and hold <🔊> on the steering wheel.
- To adjust the volume of the system feedback, push <+>/<-> on the steering wheel or turn <VOL/🔊> while the system is making an announcement.
The volume setting is also available from [Guidance Volume] in the [Settings] on the Launch Bar.
🔧 "Volume and Beeps settings"
(page 1-17)
- When setting a destination for route guidance with some search methods, such as POI, Intersection or City Center search, the search area is automatically set to the state/province where your vehicle is located. Change state/province to change the search area to another state/province if necessary.

Voice Prompt Interrupt:

In most cases, you can interrupt the voice feedback to speak the next command by pushing <🔊> on the steering wheel. After interrupting the system, wait for a tone before speaking your command.

One Shot Call:

To use the system faster when making a call, you may speak the second level command skipping speaking the first level command. For example, push <🔊> and say "Redial" after the tone without first saying "Phone".

How to see voice command screen

1. Push <🔊> to display the first screen of the voice command list.
2. Speak a command or select an item on the voice command list. The Second screen is displayed.
3. Speak a command or select an item on the voice command list. The command is executed or the next screen for further command is displayed.
4. Follow the prompts to complete the commands.

Voice command screens:

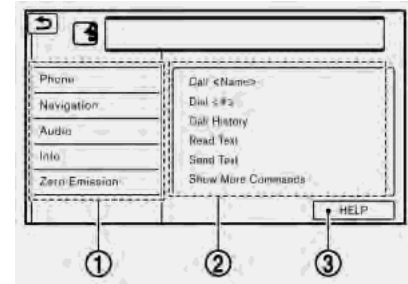

First screen

- ① Shows a list of available categories. Speak a category command or touch the key of the corresponding category.
- ② Shows a list of available commands for the selected category. Speak a preferred command.
- ③ Touch [HELP] or say "Help" to hear help announcements on how to use the system.

8. Voice recognition

INFO:

Push  to stop the help announcements.

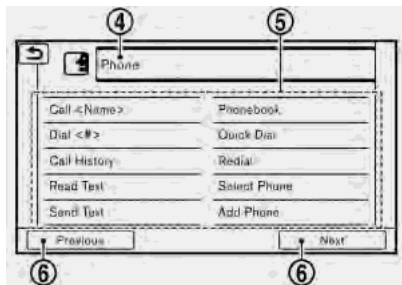

Second screen

- ④ Previously selected command.
- ⑤ Command list

You can speak a command from the list or touch the corresponding key. Preferred words can be spoken for the part of the command enclosed in $\langle \rangle$.

- ⑥ [Previous]/[Next]

Say as a command or touch to go to the previous/next screen.

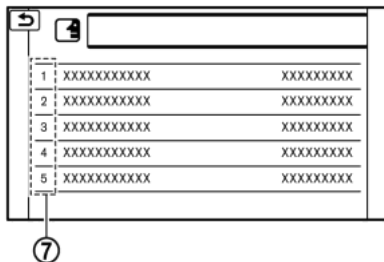

List screen

- ⑦ Speak a number from 1 to 5 or touch an item on the list screen to select the item.

How to speak numbers

The Voice Recognition system requires the user to speak numbers in a certain way when giving voice commands.

General rule:

500, 800 and 900 can be pronounced as "five hundred", "eight hundred" and "nine hundred" respectively.

For other numbers, only single digits 0 (zero) to 9 can be used. (For example, for the number "600", speaking "six zero zero" can be recognized by the system, but "six hundred" cannot.)

Example:

1-800-662-6200

"One eight hundred six six two six two zero zero"



INFO:

For the best recognition, speak "zero" for the number "0", and "oh" for the letter "o".

Voice command examples

As examples, some additional basic operations that can be performed by voice commands are described here.

Example 1 Placing call by speaking a phone number:

1. Push  located on the steering wheel.
2. Wait for the indicator to change to . Speak "Phone".

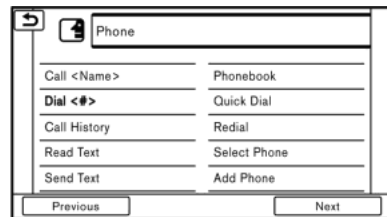

3. Speak "Dial <phone number>".

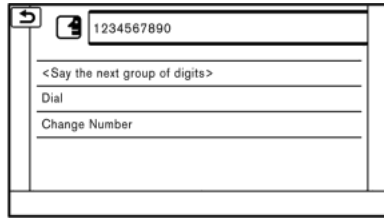

4. The phone number recognized by the system is displayed on the screen. If the number is correct, say "Dial".
5. The system will make a phone call to the spoken phone number.

Example 2 Setting home as a destination:

1. Push located on the steering wheel.
2. Wait for the indicator change to . Speak "Navigation".

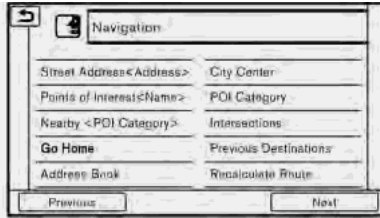

3. Speak "Go Home". The navigation system will set home as a destination.



INFO:

- Location of home must be registered to the Address Book prior to using this command.
- The step of speaking "Navigation" can be omitted.

Example 3 Displaying folders in the USB device:

1. Push located on the steering wheel.
2. Wait for the indicator change to . Speak "Audio".
3. Speak "USB Show Folders". The folders in the connected USB device will appear on the touch screen display.

8. Voice recognition

Command list

To use the Voice Recognition function, you can speak commands in the order of 1st command, 2nd command and 3rd command. You can also operate the system by directly speaking the 2nd or 3rd command.

Variable numbers or words such as names can be applied in the < > when speaking a command.

Some navigation commands are only for English.

General Command

Command	Action
Show More Commands	Display other commands of the same category.
Go Back	Corrects the last recognition result to return to the previous screen.
Exit	Cancels Voice Recognition.
Help	Announces how to use voice guidance.
Next	Skip to the next page.
Previous	Skip to the previous page.

General phone command

The following commands can be used during a phone Voice Recognition session.

Command	Action
Dial	The system makes a call to the spoken phone number.
Change Number	Change a spoken phone number.

8. Voice recognition

Phone Command

1st Command	2nd Command	3rd Command	4th Command	Action
Phone	Phonebook	<phonebook name>		Makes a call to a contact that is stored in the mobile phone. You can select the type from [Mobile], [Home], [Office], [Main] or [Other].
		<phonebook name> <type>		
	Call History	Incoming Calls		Displays an Incoming Call list.
		Outgoing Calls		Displays an Outgoing Call list.
		Missed Calls		Displays a Missed Call list.
	Dial <#>	Dial		Makes a call to a spoken phone number.
		Change Number		Change a spoken phone number.
	International Call	<phone number>		Makes an international call by allowing more than 11 digits to be spoken. You may need to include the international call prefixes and country codes.
	Redial			Makes a call to the last outgoing phone number.
	Add Phone			Use this command to connect a compatible Bluetooth® device to system. Follow the on-screen instructions to complete the pairing process from your handset.
	Select Phone	<1 - 5>		Use this command to select a phone from a list of the registered devices.
	Quick Dial	<quick dial name>		Makes a call to a contact that is stored in the Quick Dial.
		<1 - 5>		
	Call <name>			Makes a call to a contact that is stored in the Quick Dial or phonebook.
	Call	<phonebook name>		Makes a call to a contact that is stored in the mobile phone.
<phonebook name> <type>		Makes a call to a contact that is stored in the mobile phone. You can select type from [Mobile], [Home], [Office], [Main] or [Other].		

8. Voice recognition

1st Command	2nd Command	3rd Command	4th Command	Action
	Send Text	Phonebook	<name>	You can send a text message to a person by selecting a name from the phonebook.
			<name> <type>	You can send a text message to a person by selecting both name and type ([Mobile], [Home], [Office], [Main] or [Other]) from the phonebook.
		Quick Dial	<name>	A phone number registered in the Quick Dial can be selected as a recipient.
		Incoming Calls		A list of spoken call history is displayed. Select a contact to whom you wish to send the text message.
		Outgoing Calls		
		Missed Calls		
	Enter Number		Enter a phone number to which you wish to send the text message. Say "Pick Message" to confirm the phone number and select a text message.	
	Read Text	<1 - 5>	Play	You can listen to recent text messages received. Reads out a text message. Select from the list of current received messages.
			Reply	Reply to a received message.
			Call	Call the sender of the message.

Operating tips for phone command operation:

- After the command "Call", a name registered in the phonebook can be spoken for recognition, while a phone number can be spoken after the command "Dial". Names from the phonebook cannot be spoken after the command "Dial".
- Names in the phonebook can be recognized when only a first name is spoken or when spoken in the order of first name and then the last name. The system does not recognize the commands when only a last name is spoken or if the phonebook name was pronounced with last name first and then the first name.
- The system has the function to read the text messages out loud, but misreading may occur in some cases.
- Even if nicknames such as "Mom" or "Dad" are registered in the cellular phone, the voice recognition system recognizes only names. To have the system recognize the nicknames, register the entries in the [Quick Dial] from the Phone menu.

 "Quick Dial" (page 7-12)

General navigation command

The following commands can be used during the Navigation voice recognition session.

Command		Action
Select City		Search a destination from the specified city.
Change State		Change the state to search.
Calculate Route		Calculate a route.
Adjust Location		Fine-tune the destination.
Add as waypoint		The selected location will be added to the route as a waypoint.
Change Address (English only)	Change State	After the street address is specified, state, city, street, or house number change changed.
	Change City	
	Change Street	
	Change House Number	

Navigation Command

1st Command	2nd Command	3rd Command	Action
Navigation	Street Address (English only)	<Full Address>	Used to search for a street address.
		Select State	Select the state to search.
	Street Address <Full Address> (English only)		Used to search for a street address.
	Points of Interest (English only)		Speak a POI name to search for as a destination.
	Points of Interest <POI name> (English only)		Used to search for the POI within a specified state, province or city. Follow the prompts to enter the place name.

8. Voice recognition

1st Command	2nd Command	3rd Command	Action
	Points of Interest (English only)	<POI name>	Used to search for the POI within a specified state or city. Follow the prompts to enter the place name.
	Nearby	<1 - 5>	When a route is set, options of [Near Current Location], [Along Route] and [Near Destination] will be displayed. Select an item to search for the POI of the selected category in the preferred area.
	POI Category		
	Nearby <POI Category>	<1 - 5>	Say "Nearby" followed by a POI category name such as charging station, Restaurant or Parking. You can say any category name that appears when using manual controls. The system will always search for nearby matches regardless of the current state location.
	Go Home		Sets a route to your home location.
	Previous Destinations	<1 - 5>	Sets a route to a previously entered destination.
	Address Book	<Stored location name> <1 - 5>	Sets a route to a location stored in the Stored location.
	City Center (English only)	<City name>	Sets a route to a city center.
	Intersection (English only)	<Street name>	Sets a route to an intersection. To specify a city to narrow down the search, select [Select City].

8. Voice recognition

1st Command	2nd Command	3rd Command	Action
	Recalculate Route	Fastest	Sets the route search condition to find the fastest route. Sets the route search condition to find the route that is the most energy saving.
		ECO	Sets the route search condition to find the route that is most energy saving.
		Shortest distance	Sets the route search condition to find the route that is the shortest in distance.
		Minimize Freeway	Sets the route search condition to find a route with a minimal use of freeways.
	Traffic Detour		Sets the route search condition to detour traffic jam and traffic accident.
	Distance Detour		Sets a detour according to the distance selected from the list.
	Previous Start Point		Sets a route with the previous starting point as a destination.
	Cancel Route		Cancels route and deletes the destination/waypoints.
	Zoom In		Zooms in the map scale by 1 step.
	Zoom In <1-13>		Increases the magnification of the map by the number of steps specified.
	Zoom Out		Zooms out the map scale by 1 step.
	Zoom Out <1-13>		Decreases the magnification of the map by the number of steps specified.
	Zoom Streets		Change to the street map.
	North Up		Sets the 2D full map to North Up.
Heading Up		Sets the 2D full map to Heading Up.	
Full Map		Displays a full map.	

8. Voice recognition

1st Command	2nd Command	3rd Command	Action
	Split Map		Displays a split map.
	2D Map		Change the current map to a 2D Heading Up map.
	3D Map		Change the current map to a 3D map.
	Repeat Voice Guidance		Speaks the current navigation guidance.
	Voice Guidance ON		Turns the navigation guidance on.
	Voice Guidance OFF		Turns the navigation guidance off.
	Show POI Icons		Select a category of POI the icon you wish to display on map. Selected POI icons will be displayed on the map screen.
	Remove POI Icons		Select a category of the POI icon you wish to delete from the map. Selected POI icons will be deleted from the map screen.
	Route Information		Display the route information.
	Where am I?		Displays the information of the current position.

Operating tips for navigation command operation:

- Depending on the area where the vehicle is located (such as in Puerto Rico, Guam, etc.), the system may not recognize the general navigation commands.
- Points Of Interest:
 - The POI commands searches for Points of Interest registered in the navigation system.
 - When searching for POI, the search is conducted within the current state/province or the state/province specified by “Change State” command. To change the state/province, speak “Change State” after the prompt and then after the next prompt, speak the name of the state/province for which you wish to conduct the POI search. The state/province will be reset to the current state each time the voice recognition session is restarted.
 - The following POI main categories cannot be used for “Points of Interest” search with voice command operations while all registered categories can be recognized for “Nearby” search:
Others, Repair, Rental Car Agency, Parking, Police Station, Administration, ATM, Other Leisure, Bars & Clubs, Other Dealers,

8. Voice recognition

Motorcycle Dealership, Medical Offices, Post Office, Auto Parts, Banquets & Food Delivery, Carwash, Copying, Day Care, Fire Station, Laundry & Cleaners, Office Supply, Other Services, Other Shopping, Package Delivery

- Street Address:
 - Alphabet letters cannot be included when speaking a house number. When a specified house number cannot be found, a location representing the address will be displayed.
 - Speak in a natural conversational speed without pausing between words for better recognition.
 - When the system recognizes the command incorrectly, correct the search conditions using commands such as “Change State”, “Change City”, “Change Street” or “Change House Number”.

Audio Command

1st Command	2nd Command	3rd Command	Action
Audio	Play	AM	Turns to the AM band, selecting the last played station.
		FM	Turns to the FM band, selecting the last played station.
		SXM	Turns to the SiriusXM Satellite Radio band, selecting the channel last played.
		USB	Turns on the USB, selecting the last played mode.
		iPod	Turns on the iPod®, selecting the last played mode.
		Bluetooth Audio	Turns on the Bluetooth® Audio, selecting the last played mode.
		AUX	Turns on the AUX audio, selecting the last played mode.
	Play AM		Turns to the AM band, selecting the last played station.
	Play FM		Turns to the FM band, selecting the last played station.
	Play SXM		Turns to the SiriusXM Satellite Radio band, selecting the channel last played.
	Play USB		Turns on the USB, selecting the last played mode.
	Play iPod		Turns on the iPod®, selecting the last played mode.

8. Voice recognition

1st Command	2nd Command	3rd Command	Action
	Play Bluetooth Audio		Turns on the Bluetooth® Audio, selecting the last played mode.
	Play AUX		Turns on the AUX audio, selecting the last played mode.
	AM		Turns to the AM band, selecting the last played station.
	FM		Turns to the FM band, selecting the last played station.
	SXM		Turns to the SiriusXM Satellite Radio band, selecting the channel last played.
	USB		Turns on the USB, selecting the last played mode.
	iPod		Turns on the iPod®, selecting the last played mode.
	Bluetooth Audio		Turns on the Bluetooth® Audio, selecting the last played mode.
	AUX		Turns on the AUX audio, selecting the last played mode.
	AM <am frequency>		Turns to the AM band, selecting the station of the preferred frequency.
	AM Preset <1-6>		Plays the spoken AM preset station.
	FM <fm frequency>		Turns to the FM band, selecting the station of the preferred frequency.
	FM Preset <1-12>		Plays the spoken FM preset station.
	SXM <Channel number>		Turns to the SiriusXM Satellite Radio band, selecting the channel number.
	SXM <Channel name>		Turns to the SiriusXM Satellite Radio band, selecting the channel name.
	SXM Preset <1-18>		Plays the spoken SXM preset channel.
	USB Show Folders		Displays folders in the USB memory device.
	USB Play Folder <folder name>		Plays songs in the selected folder in the USB memory device.

8. Voice recognition

1st Command	2nd Command	3rd Command	Action
	USB Play File <file name>		Plays songs in the selected file in the USB memory device.
	iPod Play Artist	<artist name>	Turns on the iPod®, selecting the artist.
	iPod Play Album	<album name>	Turns on the iPod®, selecting the album.
	iPod Play Song	<song name>	Turns on the iPod®, selecting the track. You can speak the commands successively
	iPod Play Playlist	<playlist name>	Turns on the iPod®, playing the playlist that you spoke.
	iPod Show Artists		Displays a list of Artist names stored in the iPod®.
	iPod Show Albums		Displays a list of Albums in the iPod®.
	iPod Show Songs		Displays a list of songs in the iPod®.
	iPod Play Artist <artist name>	<1-5>	Turns on the iPod®, selecting the artist.
	iPod Play Album <album name>	<1 - 5>	Turns on the iPod®, selecting the album.
	iPod Play Song <song name>	<1 - 5>	Turns on the iPod®, selecting the track. You can speak the commands successively.
	iPod Play Playlist <playlist name>	<1 - 5>	Turns on the iPod®, playing the playlist that you spoke.
	iPod Play All Songs		Plays all songs in the iPod®.
	Play Artist <artist name>		Plays the songs of the corresponding song list in the iPod®.
	Play Album <album name>		
	Play Song <song name>		
	Play Playlist <playlist name>		

8. Voice recognition



INFO:

A SiriusXM Travel Link or SiriusXM Traffic subscription is necessary to receive SiriusXM information services.

"SiriusXM Travel Link" (page 6-7)

Operating tips for audio command operation:

- An audio device connected via Bluetooth® cannot be operated with the Voice Recognition system. Source change is only available for Bluetooth® streaming Audio.
- When selecting "Yes" in the pop-up screen that displays after a new USB audio device is connected, the USB audio device is registered in the voice recognition system and is selected automatically. One iPod® and one USB device can be registered in the system. If a USB audio device is newly registered, old data is overwritten. It may take a few moments to register an audio device. If you want to enable voice operation for music stored in a previously registered audio device, select the device you want to use in advance. Even when a device has been previously registered, simply connecting the device will not result in it being selected automatically.
 "Voice recognition settings" (page 8-19)
- The Voice Recognition system may not function when the song information is too long (artist names, album titles, song titles and play lists, etc.).
- The SiriusXM function will not operate without a subscription to SiriusXM Satellite Radio.
- When playing USB files with the voice recognition system, do not pronounce the extension attached to the file name (such as ".mp3").
- Song titles registered in ID3 tags cannot be pronounced for voice recognition operation.

Information Command

1st Command	2nd Command	Action
Information	Where am I?	Displays information of the current position.
	SXM Weather Map	Displays the SiriusXM Weather map.
	SXM Current Weather	Displays the nearby weather (current weather).
	SXM Weather Forecast	Displays the weather forecast.
	SXM Movie Listings	Displays SiriusXM Movie Listings.
	SXM Stocks	Displays SiriusXM stock information.
	SXM Sports Scores	Displays sports scores.
	SXM Traffic	Turns the traffic information system on or off.
	Favorite Feeds	Plays Favorite Feeds.
	All Information Feeds	Plays Information Feeds.
	Update Stations	Updates nearby charging stations.



INFO:

A SiriusXM Travel Link or SiriusXM Traffic subscription is necessary to receive SiriusXM information services.

"SiriusXM Travel Link" (page 6-7)

8. Voice recognition

Zero Emission Command

1st Command	2nd Command		Action
Zero Emission	Driving Range		Displays the driving range screen.
	Nearby Station	Near Current Location	Searches for charging stations near current location.
		Along Route	Searches for charging stations along route.
		Near Destination	Searches for charging stations near destination.
	Update Stations		Updates nearby charging stations.
	Energy Usage		Displays Energy Usage information.

VOICE RECOGNITION SETTINGS

The voice recognition settings can be changed.

1. Touch [Setting] on the Launch Bar.
2. Touch [Voice Recognition].
3. Touch the item you would like to set.

Available settings

- [Minimize Voice Feedback]:
Turns the minimize voice feedback function on/off. When this item is turned on, short and minimized voice feedback will be provided.
- [Audio device setting]:
Select an audio device to be operated via the Voice Recognition system from the audio devices connected to the USB connection port. A device with an indicator light illuminated can be operated with the Voice Recognition system.

8. Voice recognition

MEMO

9 General system information

Current vehicle location	9-2	Map data	9-9
Display of current vehicle location	9-2	How to handle the Map SD card	9-9
What is GPS (Global Positioning System)?	9-2	How to order map data updates	9-9
Incorrect display of vehicle position	9-3	About map data	9-9
Detailed Map Coverage Areas (MCA) for navigation system	9-5	End-user terms	9-11
When gray/dark green road is displayed on map	9-5	How to handle display	9-13
Route calculation	9-6	Characteristics of liquid crystal display	9-13
Route guidance	9-8	Maintenance of display	9-14
Repeating voice guidance	9-8	How to handle the SD card	9-14
Notes on voice guidance	9-8	How to handle USB memory	9-15
		USB memory device	9-15

9. General system information

CURRENT VEHICLE LOCATION

DISPLAY OF CURRENT VEHICLE LOCATION

This navigation system combines the data obtained from the vehicle (by gyro sensor) and from GPS (Global Positioning System) satellites to calculate the current location of the vehicle. This position is then displayed throughout route guidance to a destination.

WHAT IS GPS (Global Positioning System)?

GPS is a position detecting system that uses satellites deployed by the U.S. government. This navigation system receives radio signals from three or more different satellites that orbit 13,049 miles (21,000 km) above the earth in space, and detect the position of the vehicle by utilizing the principle of triangulation.

Positioning adjustment

When the system judges that the vehicle position is not accurate based on vehicle speed and gyro sensor data calculations, the system will automatically adjust the position of the vehicle icon using GPS signals.

Receiving signals from GPS satellites

The reception of GPS signals can be weak, depending on the environment. Vehicles in the following areas/environments may not receive GPS signals.

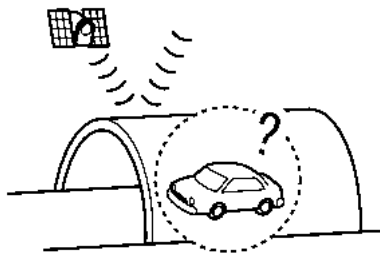

- Inside tunnels or parking garages

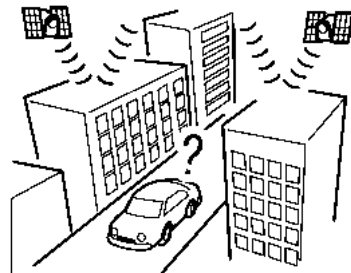

- In areas with numerous tall buildings

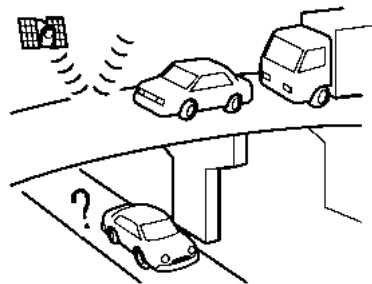

- Under multi-layered highways

9. General system information

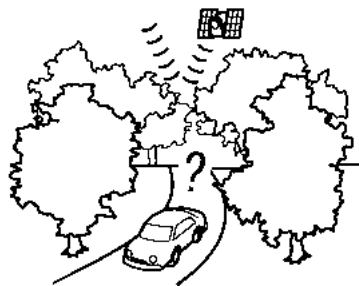

- Areas with numerous tall trees

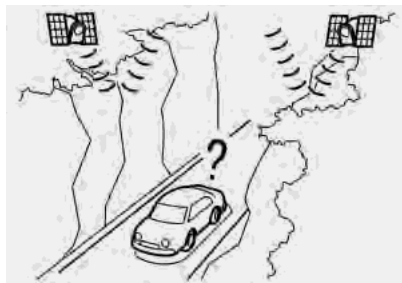

- In a canyon



INFO:

The GPS antenna is located on the instrument panel inside the vehicle. Do not place any objects, especially cellular phones or transceivers, on the instrument panel. Because the strength of the GPS signal is approximately one billionth of that of TV waves, phones and transceivers will affect or may totally disrupt the signal.

INCORRECT DISPLAY OF VEHICLE POSITION

The following cases may affect the display accuracy of the vehicle's position or traveling direction. The accuracy will return to normal if the driving conditions return to normal.

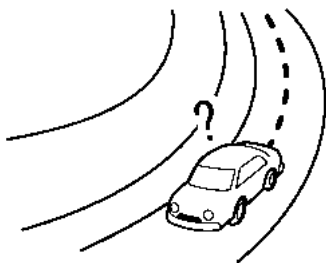

- When there is a similar road nearby.

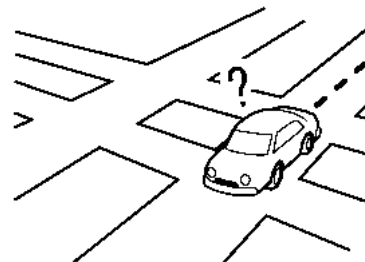

- When the vehicle is traveling in an area with a grid pattern road system.

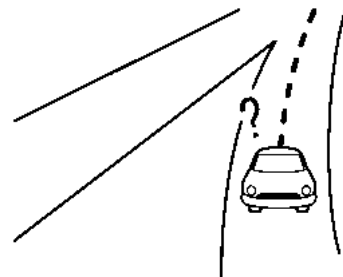

- When the vehicle is passing through a large Y-shaped intersection/junction.

9. General system information

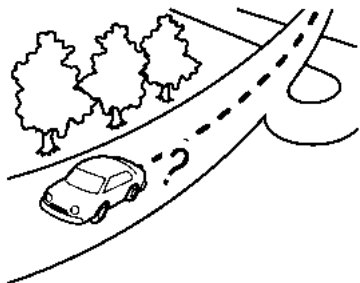

- When the vehicle is traveling on a continuous, slowly curving road.

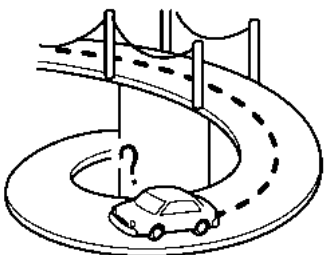

- When the vehicle is on a loop bridge.

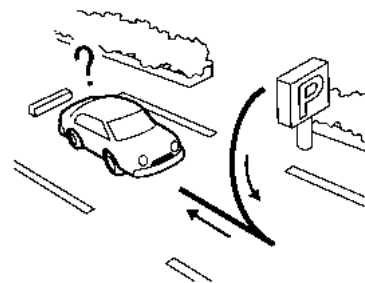

- When repeatedly turning left or right, or driving in zigzags.

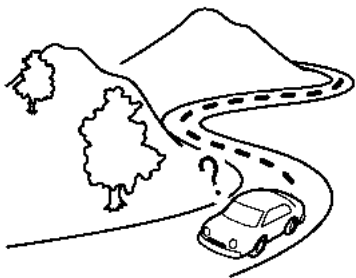

- When the vehicle is traveling on a road with repeating S-shaped curves.



- When the vehicle is on a snow-covered or unpaved road.

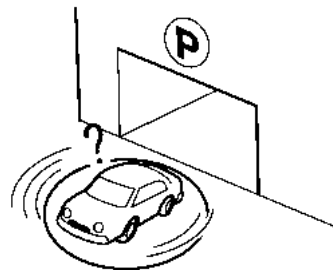

- When the vehicle is rotated on a parking lot turntable while the power switch placed in the OFF position.

9. General system information

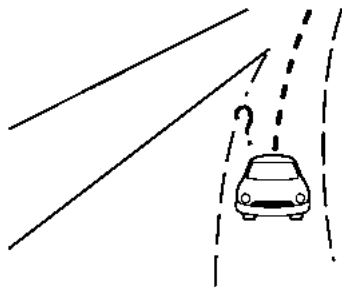

- When driving on a road not displayed on the map screen or a road that has been changed due to additional construction or other reasons.

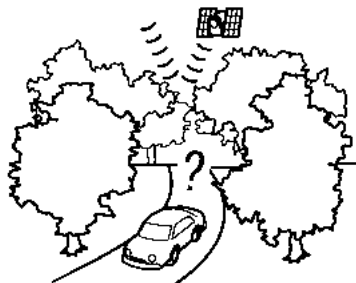

- When the GPS positioning accuracy is low.



INFO:

- The vehicle icon may be misaligned when starting the vehicle just after the READY to drive indicator light is turned on.
- The vehicle icon may also be misaligned if different sized tires or tire chains are installed.
- The system has a function that automatically corrects the vehicle icon position when it is misaligned from the actual position.
- Vehicle position correction by GPS may not function when the vehicle is stopped.
- If the vehicle icon position does not return to normal even after driving for a while, correct the vehicle icon position manually.

DETAILED MAP COVERAGE AREAS (MCA) FOR NAVIGATION SYSTEM

This system is designed to help guiding to the destination, and it also performs other functions as outlined in this manual. However, the system must be used safely and properly. Information concerning road conditions, traffic signs and the availability of services may not always be up-to-date. The system is not a substitute

for safe, proper and legal driving.

Map data covers select metropolitan areas.

Map data includes two types of areas: "Detailed coverage areas" providing all detailed road data and other areas showing "Main roads only".



INFO:

Detailed map data is not available in many areas and is generally limited to select major metropolitan areas.

WHEN GRAY/DARK GREEN ROAD IS DISPLAYED ON MAP

- When you are driving on a road displayed in gray after the vehicle has deviated from the suggested route during route guidance, automatic re-routing may not start immediately.
- The navigation system does not provide route guidance for roads displayed in dark green. Therefore, if the destination is set on a road displayed in dark green, the enlarged map display will return to the ordinary map screen at some point on a suggested route that is near the destination. Also, voice guidance will stop at some point on a suggested route that is near the

9. General system information

destination.

- Places information and street names near roads displayed in gray may not be contained in the map data.

ROUTE CALCULATION

- There may be cases where carpool lanes are included on a suggested route when the automatic rerouting function is activated, even if the [Time Restricted Rd] is set to [Use Restriction Info] or [Avoid].

 "Route Settings" (page 3-47)

- The navigation system does not provide route guidance for roads displayed in dark green.
- If the destination is set on a dark green road, the enlarged map display will switch to the ordinary map screen at some point and suggest a route that is near the destination. The distance and direction to the endpoint of the suggested route will be displayed in the lower right corner of the screen. Also, at this time, voice guidance will announce, "The route to your destination includes roads through incomplete map areas. Voice guidance will not be provided in these areas."

When approaching the endpoint of the suggested route, voice guidance will announce, "Entering the road with incomplete map data. Please use the direction arrow and distance information to proceed to your destination."

To reach the destination, refer to the map screen. Always follow actual roads and regulations and drive safely.

- The suggested route may not be the shortest, nor are other circumstances such as traffic jams considered.
- Because of the inevitable difference in road conditions and circumstances between the time you use this system and the time the information was produced for the map data, there may be discrepancies in roads and regulations. In such cases, actual road conditions and regulations take precedence over map data information.
- During route calculation, the map will not scroll, however the vehicle icon will move according to the actual vehicle's movement.
- During route calculation, buttons such as <MAP> and <MENU> will be disabled.
- In some cases, after the calculation is complete, the calculated route may not be immediately displayed.
- Waypoints that have been passed will be disregarded by rerouting calculation.

9. General system information

- If you scroll the map while the suggested route is being drawn, it may take more time to finish drawing.
- Route calculation may not be completed in the following cases.
 - If there is no main road within a range of 1.5 miles (2.5 km) from the vehicle, a message saying so will appear on the screen. Try recalculating when the vehicle is closer to a main road.
 - If there is no main road within a range of 1.5 miles (2.5 km) from the destination or waypoint, a message saying so will appear on the screen. Try setting the location closer to a main road.
 - If the vehicle is too close to the destination or if there are no roads to the destination, a message saying so will appear on the screen.
 - If it is impossible to reach the destination or waypoints because of traffic regulations, etc.
 - If the only route to reach the destination or waypoints is extremely complicated.
- The following may occur when the route is displayed.
 - If you calculate a route on a main road, the starting point of the route may not exactly match the current vehicle location.
 - The endpoint of the route may not exactly match the destination.
 - If you calculate a route on a main road, the system may display a route from another main road. This may be because the position of the vehicle icon is not accurate. In this case, park the vehicle in a safe location and reset the vehicle icon, or continue driving to see if the position of the vehicle icon is automatically adjusted before recalculating the route.
 - There are cases in which the system shows an indirect route to reach the destination or waypoints, if you set them from stored or facility information. In order to correct this, you must be careful about the traffic direction, especially when lanes with different travel directions are shown separately, such as interchanges and service areas.
 - This system makes no distinction between limited traffic control and total control (blockage). It may show an indirect route even if the road is usable.
- Even if the ferry preference is set to OFF, a route that uses a ferry line may be suggested.

9. General system information

ROUTE GUIDANCE



INFO:

The system will announce street names when the system language is set to English. Street names are not announced when the system is set to French/Spanish.

REPEATING VOICE GUIDANCE

This function is available throughout route guidance, from the time after the route calculation is completed until the vehicle arrives at the destination. Push and hold **<MAP>**. Voice guidance will be repeated.



INFO:

If **<MAP>** is pushed and held when the vehicle is going in the wrong direction, voice guidance will announce: "Please make a legal U-turn if possible."

NOTES ON VOICE GUIDANCE

- Voice guidance in this system should be regarded as a supplementary function. When driving the vehicle, check the route on the map and follow the actual roads and traffic regulations.
- Voice guidance is activated only for intersections with certain conditions. There may be cases where the vehicle has to turn, but voice guidance is not provided.
- Voice guidance contents may vary, depending on the direction of the turn and the type of intersection.
- The voice guidance timing will vary depending on the situation.
- When the vehicle has deviated from the suggested route, voice guidance is not available. The system will not announce this. Refer to the map and recalculate the route.
 - "Recalculating route" (page 3-43)
- Voice guidance may not accurately correspond with road numbers and directions at freeway junctions.
- Voice guidance may not accurately correspond to street names at freeway exits.
- The displayed street names may sometimes differ from the actual names.
- Voice guidance is not available when the [Guidance Voice] is turned off.
 - "Volume and Beeps settings" (page 1-17)
- Voice guidance will start when the vehicle enters the suggested route. Refer to the map for directions to the starting point of the route.
- When approaching a waypoint, voice guidance will announce, "You have arrived at waypoint 1 (2, 3, 4,...)." Voice guidance will switch to the next section of the route. When voice guidance is not available, refer to the map for directions.
- In some cases, voice guidance ends before arrival at the destination. Refer to the destination icon on the map to reach the destination.
- If the system recognizes on which side the destination (waypoint) is located, voice guidance will announce "on the right/left" after announcing the arrival at the destination.
- Voice guidance may be partially operational or inoperative due to the angle of roads at an intersection.
- Because freeway lane information is available only for approximately 7,000 major freeways in North America, it is not possible to display information for all junctions and exits.

- Freeway exit information may differ from the information on the actual exit signs.
- Because it is not possible to consider data concerning roads that are seasonally available or unavailable, a route may be displayed that does not match the actual traffic restrictions. Be sure to follow the actual traffic restrictions while driving.
- Canada and Alaska contain many roads with incomplete map data. As a result, when searching for a route, the route may include roads with incomplete data. In regions where road data is not complete, voice guidance may stop for long periods of time. Be sure to follow the actual traffic restrictions while driving.

MAP DATA

HOW TO HANDLE THE MAP SD CARD

An SD card that includes the map data is inserted. When handling the Map SD card, please be careful and adhere to the following instructions:

- An SD card is inserted in the slot. This is the SDHC card that is exclusively used for this device. This card includes the map data. The SDHC card is necessary to operate the device. Do not remove this card except when updating the map data is required.
- Never analyze, modify, delete or format the map data. Doing so may cause an improper operation of the device.
- The SDHC card that is exclusively used for this device does not work properly if it is inserted in another device.
- The map data cannot be used even if it is copied to another SDHC card.
- Do not remove the SDHC card containing map data from the system. Using the system with the SDHC card containing map data removed will prevent some functions from operating.



NOTE:

Do not remove the SD card containing map data that is inserted in the slot. When this SD card containing map data is removed the navigation system will not operate. If the SD card containing map data is accidentally removed, after reinserting the SD card containing map data into the slot, place the power switch in the OFF position and then place it back in the ON position.

HOW TO ORDER MAP DATA UPDATES

Visit NissanNavigation.com or contact the NISSAN NAVIGATION SYSTEM HELPDESK to order updated map data (see contact details described earlier in this manual).

ABOUT MAP DATA

1. This map data has been prepared by CLARION CO., LTD. (CLARION), under license from HERE. has added, processed and digitized data based on the digital road map data of HERE. Due to the production timing of the map data, some new roads may not be included in this map data or some of the names or roads may be different from those at the time you use this map data.

9. General system information

2. Traffic control and regulation data used in this map data may be different from those at the time you use this map data due to the data production timing. When driving your vehicle, follow the actual traffic control signs and notices on the roads.
3. Reproducing or copying this map software is strictly prohibited by law.

Published by Nissan North America, Inc.

© 2017 HERE. All Rights Reserved.

© ZENRIN CO., LTD. 2017. All rights reserved.



WARNING

- This navigation system should not be used as a substitute for your own judgement. Any route suggestions made by this navigation system may never override any local traffic regulations, your own judgement, and/or knowledge of safe driving practices. Disregard route suggestions by the navigation system if such suggestions would: cause you to perform an hazardous or illegal maneuver, place you in an hazardous situation, or route you into an area you consider unsafe.

- The advice provided by the navigation system is to be regarded only as a suggestion. There may be situations where the navigation system displays the vehicle's location incorrectly, fails to suggest the shortest course, and/or fails to direct you to your desired destination. In such situations, rely on your own driving judgement, taking into account current driving conditions.
- Do not use the navigation system to route you to emergency services. The database does not contain a complete listing of locations of emergency service providers such as police, fire stations, hospitals and clinics. Please use your judgement and your ability to ask for directions in these situations.
- As the driver you solely are responsible for your driving safety.
 - In order to avoid traffic accidents, do not operate the system while driving.
 - In order to avoid traffic accidents, operate the system only when the vehicle is stopped at a safe place and the parking brake is set.

- In order to avoid traffic accidents or traffic offence, remember that actual road conditions and traffic regulations take precedence over the information contained on the navigation system.
- Accordingly, the Software may contain inaccurate or incomplete information due the passage of time, changing circumstances, and due to the nature of the sources used. Please observe the actual traffic circumstances and regulations at all times while driving.
- In a situation when actual road conditions and traffic regulations differ from the information contained on the navigation system, then abide by traffic rules.
- The navigation system does not provide, or account for in any way, information regarding traffic and road laws; speed restrictions; road conditions including road slope, grade, and/or surface conditions; obstruction information including bridge and tunnel height and width, and/or other prevailing driving and/or road conditions. Always rely on

your own driving judgment, taking into account current driving conditions.

- **Minimize the amount of time spent viewing the screen while driving.**

The marks of companies displayed by this product to indicate business locations are the marks of their respective owners. The use of such marks in this product does not imply any sponsorship, approval, or endorsement by such companies of this product.

END-USER TERMS

The data ("Data") is provided for your personal, internal use only and not for resale. It is protected by copyright, and is subject to the following terms and conditions which are agreed to by you, on the one hand, and CLARION CO., LTD. ("CLARION") and its licensors (including their licensors and suppliers) on the other hand.

© 2017 HERE. All rights reserved.

This data includes information taken with permission from Canadian authorities, including © Her Majesty, © Queen's Printer for Ontario, © Canada Post, GeoBase®, © Department of Natural Resources Cana-

da. All rights reserved.

HERE holds a non-exclusive license from the United States Postal Service® to publish and sell ZIP+4® information.

© United States Postal Service® 2017. Prices are not established, controlled or approved by the United States Postal Service®. The following trademarks and registrations are owned by the USPS: United States Postal Service, USPS, and ZIP+4.

Terms and conditions

Personal Use Only. You agree to use this Data together with Nissan Automotive Products for the solely personal, non-commercial purposes for which you were licensed, and not for service bureau, time-sharing or other similar purposes. Accordingly, but subject to the restrictions set forth in the following paragraphs, you agree not to otherwise reproduce, copy, modify, decompile, disassemble or reverse engineer any portion of this Data, and may not transfer or distribute it in any form, for any purpose, except to the extent permitted by mandatory laws. Multi-disc sets may only be transferred or sold as a complete set as provided by CLARION and not as a subset thereof.

Restrictions. Except where you have been specifically licensed to do so by CLARION, and without limiting the preceding paragraph, you may not (a) use this Data with any products, systems, or applications installed or otherwise connected to or in communication with vehicles, capable of vehicle navigation, positioning, dispatch, real time route guidance, fleet management or similar applications; or (b) with or in communication with any positioning devices or any mobile or wireless-connected electronic or computer devices,

9. General system information

including without limitation cellular phones, palmtop and handheld computers, pagers, and personal digital assistants or PDAs.

Warning. The Data may contain inaccurate or incomplete information due to the passage of time, changing circumstances, sources used and the nature of collecting comprehensive geographic data, any of which may lead to incorrect results.

No Warranty. This Data is provided to you "as is," and you agree to use it at your own risk. CLARION and its licensors (and their licensors and suppliers) make no guarantees, representations or warranties of any kind, express or implied, arising by law or otherwise, including but not limited to, content, quality, accuracy, completeness, effectiveness, reliability, fitness for a particular purpose, usefulness, use or results to be obtained from this Data, or that the Data or server will be uninterrupted or error-free.

Disclaimer of Warranty: CLARION AND ITS LICENSORS (INCLUDING THEIR LICENSORS AND SUPPLIERS) DISCLAIM ANY WARRANTIES, EXPRESS OR IMPLIED, OF QUALITY, PERFORMANCE, MERCHANTABILITY, FITNESS FOR A PARTICULAR PURPOSE OR NON-INFRINGEMENT. Some States, Territories and Countries do not allow certain

warranty exclusions, so to that extent the above exclusion may not apply to you.

Disclaimer of Liability: CLARION AND ITS LICENSORS (INCLUDING THEIR LICENSORS AND SUPPLIERS) SHALL NOT BE LIABLE TO YOU: IN RESPECT OF ANY CLAIM, DEMAND OR ACTION, IRRESPECTIVE OF THE NATURE OF THE CAUSE OF THE CLAIM, DEMAND OR ACTION ALLEGING ANY LOSS, INJURY OR DAMAGES, DIRECT OR INDIRECT, WHICH MAY RESULT FROM THE USE OR POSSESSION OF THE INFORMATION; OR FOR ANY LOSS OF PROFIT, REVENUE, CONTRACTS OR SAVINGS, OR ANY OTHER DIRECT, INDIRECT, INCIDENTAL, SPECIAL OR CONSEQUENTIAL DAMAGES ARISING OUT OF YOUR USE OF OR INABILITY TO USE THIS INFORMATION, ANY DEFECT IN THE INFORMATION, OR THE BREACH OF THESE TERMS OR CONDITIONS, WHETHER IN AN ACTION IN CONTRACT OR TORT OR BASED ON A WARRANTY, EVEN IF CLARION OR ITS LICENSORS HAVE BEEN ADVISED OF THE POSSIBILITY OF SUCH DAMAGES. Some States, Territories and Countries do not allow certain liability exclusions or damages limitations, so to that extent the above may not apply to you.

Export Control. CLARION shall not export from anywhere any part of the Data or any direct product thereof except in compliance with, and with all licenses and

approvals required under, applicable export laws, rules and regulations, including but not limited to the laws, rules and regulations administered by the Office of Foreign Assets Control of the U.S. Department of Commerce and the Bureau of Industry and Security of the U.S. Department of Commerce. To the extent that any such export laws, rules or regulations prohibit NT from complying with any of its obligations hereunder to deliver or distribute Data, such failure shall be excused and shall not constitute a breach of this Agreement.

Entire Agreement. These terms and conditions constitute the entire agreement between CLARION (and its licensors, including their licensors and suppliers) and you pertaining to the subject matter hereof, and supersedes in their entirety any and all written or oral agreements previously existing between us with respect to such subject matter.

Governing Law. The above terms and conditions shall be governed by the laws of the Netherlands, without giving effect to (i) its conflict of laws provisions, or (ii) the United Nations Convention for Contracts for the International Sale of Goods, which is explicitly excluded. You agree to submit to the jurisdiction of the Netherlands for any and all disputes, claims and

9. General system information

actions arising from or in connection with the Data provided to you hereunder.

Government End Users. If the Data is being acquired by or on behalf of the United States government or any other entity seeking or applying rights similar to those customarily claimed by the United States government, the Data is a "commercial item" as that term is defined at 48 C.F.R. ("FAR") 2.101, is licensed in accordance with the End-User Terms under which this Data was provided, and each copy of the Data delivered or otherwise furnished shall be marked and embedded as appropriate with the following "Notice of Use," and shall be treated in accordance with such Notice:

NOTICE OF USE

CONTRACTOR (MANUFACTURER/ SUPPLIER) NAME: HERE

CONTRACTOR (MANUFACTURER/SUPPLIER) ADDRESS:

c/o Nokia 425 West Randolph Street,
Chicago, Illinois 60606

This Data is a commercial item as defined in FAR 2.101 and is subject to the End-User Terms under which this Data was provided.

© 2017 HERE - All rights reserved.

If the Contracting Officer, federal govern-

ment agency, or any federal official refuses to use the legend provided herein, the Contracting Officer, federal government agency, or any federal official must notify HERE prior to seeking additional or alternative rights in the Data.

HOW TO HANDLE DISPLAY

The display is a liquid crystal display and should be handled with care.



WARNING

Never disassemble the display. Some parts utilize extremely high voltage. Touching them may result in serious personal injury.

CHARACTERISTICS OF LIQUID CRYSTAL DISPLAY

- If the temperature inside the vehicle is especially low, the display will stay relatively dim or the movement of the images may be slow. These conditions are normal. The display will function normally when the interior of the vehicle has warmed up.
- Some pixels in the display are darker or brighter than others. This condition is an inherent characteristic of liquid crystal displays, and it is not a malfunction.
- A remnant of the previous display image may remain on the screen. This screen burn is inherent in displays, and it is not a malfunction.

9. General system information

- The screen may become distorted by strong magnetic fields.

MAINTENANCE OF DISPLAY



CAUTION

- **To clean the display screen, use a dry, soft cloth. If additional cleaning is necessary, use a small amount of neutral detergent with a soft cloth.**
- **Clean the display with the power switch in the OFF position. If the display is cleaned while the power switch is placed in the ON position or when the READY to drive indicator light is on, unintentional operation may occur.**
- **To clean the display, never use a rough cloth, alcohol, benzine, thinner or any kind of solvent or paper towel with a chemical cleaning agent. They will scratch or deteriorate the panel.**
- **Do not splash any liquid such as water or car fragrance on the display. Contact with liquid will cause the system to malfunction.**

cloth. If additional cleaning is necessary, use a small amount of neutral detergent with a soft cloth. Never spray the screen with water or detergent. Dampen the cloth first, then wipe the screen.

HOW TO HANDLE THE SD CARD

When handling the SD card, please be careful and adhere to the following instructions:

- Always follow the instructions described in this manual and in the handbook attached to the SD card when using an SD card in this device.
- Do not handle an SD card with wet hands. Doing so may cause electric shock or a malfunction.
- Do not allow hands or metal objects to contact the terminal area of SD cards.
- Do not place SD cards on the instrument panel, on any place with direct sunlight or in moist circumstances. Doing so may damage or deform the SD card.
- Do not use any conventional cleaner, benzine, thinner or antistatic spray.
- Do not use SD cards in any place where static electricity or electric noise adversely affects SD cards. This may cause data corruption or data loss.
- SD card optimization must not be performed.

To clean the display screen, use a dry, soft

- Always place the SD card in its storage case when not in use.
- If an SD card is disposed of when it is not used, it is recommended not only to delete the stored data but also to physically break the card.

HOW TO HANDLE USB MEMORY

USB MEMORY DEVICE

- Never touch the terminal portion of the USB memory device.
- Do not place heavy objects on the USB memory device.
- Do not store the USB memory device in highly humid locations.
- Do not expose the USB memory device to direct sunlight.
- Do not spill any liquids on the USB memory device.

Refer to the USB memory device Owner's Manual for the details.

9. General system information

MEMO

10 Troubleshooting guide

Customer assistance	10-2	Bluetooth® Hands-Free Phone System	10-15
System unit	10-3	NissanConnect® EV and Services	10-18
Liquid crystal display	10-3	Navigation	10-19
Unique EV functions	10-5	Basic operations	10-19
Driving range	10-5	Vehicle icon	10-20
Charging stations	10-6	Route calculation and visual guidance	10-22
Energy usage information display	10-7	Voice guidance	10-24
Audio system	10-8	Traffic information	10-25
HD Radio technology (for U.S.)	10-8	Voice recognition	10-26
iPod® player	10-10	Apple CarPlay™ (if so equipped)	10-29
USB memory device	10-12	Android Auto™	10-30
Bluetooth® streaming audio	10-13		

10. Troubleshooting guide

CUSTOMER ASSISTANCE

For assistance or to order updated map data, contact the NISSAN NAVIGATION SYSTEM HELPDESK. For other assistance or inquiries, contact NISSAN Consumer Affairs Department or NissanConnect® EV and Services customer service. See contact details described earlier in this manual.

SYSTEM UNIT

LIQUID CRYSTAL DISPLAY

Symptom	Possible cause	Possible solution
The screen is too dark.	The cabin temperature is too low.	Wait until the cabin temperature becomes moderate.
	Screen brightness is set to the maximum darkness.	Adjust the brightness setting of the screen. ☞ "Display settings" (page 1-16)
The screen is too bright.	Screen brightness is set to the maximum brightness.	Adjust the brightness setting of the screen. ☞ "Display settings" (page 1-16)
A small black spot or a small bright spot appears on the screen.	This is a typical phenomenon for liquid crystal displays.	This is not a malfunction.
A dot or stripe pattern appears on the screen.	Electromagnetic waves that are generated from neon billboards, high voltage electric power cables, ham radios or other radio devices equipped to other vehicles may adversely affect the screen.	This is not a malfunction.
Image lag appears on the screen.	This is a typical phenomenon for liquid crystal displays.	This is not a malfunction.
Image motion displayed on the screen is slow.	The cabin temperature is less than 50°F (10°C).	Wait until the cabin temperature rises to within 50°F (10°C) and 122°F (50°C).
When looking at the screen from an angle, the screen lightens or darkens.	This is a typical phenomenon for liquid crystal displays.	Adjust the brightness setting of the screen. ☞ "Display settings" (page 1-16)

10. Troubleshooting guide

Symptom	Possible cause	Possible solution
The screen turns blue or an error message is displayed on the touch screen display.	A system malfunction has occurred.	Contact a NISSAN certified LEAF dealer for an inspection.
	The SD card is not inserted into the slot correctly.	If the SD card containing map data is accidentally removed, after reinserting the SD card containing map data into the slot, push the power switch to the OFF position and then push back to the ON position again.
Navigation system related functions cannot be operated.	The SD card is not inserted into the slot.	Insert the appropriate SD card.

UNIQUE EV FUNCTIONS

DRIVING RANGE

Symptom	Possible cause	Possible solution
The driving range cannot be displayed.	The power switch is in the ACC position.	The driving range can be displayed when the power switch is in the ON position or when the READY to drive indicator light is on.
	It cannot be displayed because the distance to empty is too short.	Charge the battery. Once the distance to empty increased it will be displayed.
The driving range is displayed in an oval shape.	As a result of the system correcting latitude and longitude, it may not be displayed as a circle.	This is not a malfunction.
The distance to empty that is displayed in the lower left hand side of the driving range and the scale of the map do not match.	As the map is displayed in 2D, the distance to empty may differ from the actual distance on the road.	This is not a malfunction. Drive using the numerical value on the lower left hand side of the screen as a guide.

10. Troubleshooting guide

CHARGING STATIONS

Symptom	Possible cause	Possible solution
The charging station icon display setting is off but icons are still displayed on the map.	The charging station displayed has been set as a stored location.	This is not a malfunction.
Searched for charging stations because charge recommendation guidance and the low battery warning were displayed, but could not find any.	In an area where the number of charging stations is low, it may not be possible to find a charging station located near the vehicle.	This is not a malfunction.
Charging station information is not displayed.	Information is not provided for all charging stations, so there may be cases when information is not displayed.	This is not a malfunction. Contact charging stations beforehand by phone to confirm whether they can be used.
Quick charging stations are not displayed.	[QUICK CHARGE] may be set to OFF in the [Charge Port Types to Include in Station Searches] setting.	Turn on the [QUICK CHARGE] setting.  "Unique EV function settings" (page 2-9)
The charging station information displayed is incorrect.	The map data is old.	Connect to the Nissan Data Center and update charging station information. Alternatively, purchase new map data and update the system.
I went to the charging station that I searched for but the information was incorrect and I could not charge the battery.	The map data is old.	Connect to the Nissan Data Center and update charging station information. Alternatively, purchase new map data and update the system.
	Charging station facilities have changed, or the EVSE (Electric Vehicle Supply Equipment) equipped cannot be used.	Contact the charging station by phone beforehand to check whether facilities can be used.

ENERGY USAGE INFORMATION
DISPLAY

Symptom	Possible cause	Possible solution
The driving range increases/decreases when the air conditioner/heater is ON/OFF that is displayed in the energy usage information screen is displayed as +0 mile (+0 km) or -0 mile (-0 km).	The power used for the air conditioner/heater will decrease in response to the power used by the traction motor and the increase/decrease difference of the driving range will be under ± 1 mile (± 1 km). Also, when the Li-ion battery available charge is low, the increase/decrease of the driving range will also become smaller.	This is not a malfunction.

10. Troubleshooting guide

AUDIO SYSTEM

HD RADIO TECHNOLOGY (for U.S.)

Sound

Symptom	Possible cause	Possible solution
Delay in digital audio on HD Radio broadcasts.	The radio acquires an analog station first and blends to a digital signal.	This is not a malfunction.
Audio skips, stutters, or echoes.	The radio station has not properly aligned the digital and analog audio.	Verify correct operation on another station. Report any station with poor performance.
Volume changing up/down.	The radio station has not properly aligned digital and analog audio level.	Verify correct operation on another station and check www.hdradio.com for stations in the area. Report any station with poor performance.
Sound fading in and out.	The transition between analog and digital is taking place (blending).	Verify transition performance on several stations in the area. Report any stations with poor alignment.
Excessive blending (Transition between analog and digital).	The receiver is located near the edge of the digital coverage area.	Refer to hdradio.com to verify radio stations in your coverage area.
Digital audio not better than analog audio.	Audio processing on the digital audio at a station can potentially decrease the digital audio sound quality.	Verify correct operation on another station. Report any station with poor performance.

10. Troubleshooting guide

Functional

Symptom	Possible cause	Possible solution
Keep losing my local stations.	The digital coverage is slightly less than the analog signal coverage.	Verify correct operation on another station. This is expected behavior.
	Shadowing (urban/terrain) can cause reduced digital coverage.	Verify correct operation on another station.
Some data fields are blank.	Text information is sent at the broadcaster's discretion.	Verify correct operation on another station. Report station issues.
Text information is truncated / appears to be more available.	The display is limited to a fixed number of characters and more data is being sent than can be shown.	This is an intended behavior.
AM reception changes at night.	AM stations are required by the government (FCC) to lower their power at night.	This is not a malfunction.

10. Troubleshooting guide

iPod® PLAYER

Symptom	Possible cause	Possible solution
The system does not recognize an iPod®.	A connector cable is not correctly connected, or the iPod® does not correctly operate.	Connect the connector cable again. If the system does not recognize the iPod® after this operation is performed, reset the iPod®.
	The iPod® that is to be connected is not compatible with the system.	Check the iPod® model and firmware versions available for the system.
	A USB extension cable is not correctly connected.	Do not use a USB extension cable.
	The cable is rapidly connected to or disconnected from the USB connection port.	Slowly connect or disconnect the USB cable.
An iPod® cannot be operated.	The iPod® is connected to the in-vehicle audio system while headsets, etc. are connected to the iPod®.	Remove all equipment from the iPod® after disconnecting the iPod® from the system, and then connect it to the system again.
	The iPod® is not operating normally.	Disconnect the iPod® from the in-vehicle audio system, and then connect it to the system again.
	The system plays back an album/file that includes a particular album art.	Disconnect the iPod® from the in-vehicle audio system, and then reset the iPod®. Disable the album art, and then connect the iPod® to the system.  "iPod® Menu" (page 4-21)
An iPod® does not respond.	There are too many files in a category.	Decrease the number of files in a category (less than 65500 files).
	The shuffle function is turned on.	Turn off the shuffle function if many files are stored on the iPod®.
Music cannot be played back.	A connector is not connected to the iPod®.	Firmly connect the connector to the iPod®.
Playback cuts out.	The sound cuts due to vibration resulting from an unstable location of the iPod®.	Place the iPod® on a stable location where it does not roll over.

10. Troubleshooting guide

Symptom	Possible cause	Possible solution
Distorted sound occurs.	The EQ (equalizer) function of the iPod® is turned on.	Turn off the EQ (equalizer) function on your iPod®.
Battery charge of an iPod® takes longer.	Battery charge of the iPod® may take longer while an iPod® is playing back.	If the iPod® needs to be charged, it is recommended to stop playing the music.
Battery charge of an iPod® is unavailable.	The cable that is connected to the iPod® may be damaged or improperly connected.	Check the cable currently in use.
Functions cannot be operated using an iPod® that is connected to the in-vehicle audio system.	-	The operation of an iPod® must be performed using the in-vehicle audio system after the iPod® is connected to the system.
Sound skips.	Surrounding circumstances (noise, etc.) may cause the sound to skip.	This does not indicate a malfunction.
	A USB extension cable is used.	Do not use a USB extension cable.



10. Troubleshooting guide

USB MEMORY DEVICE

Symptom	Possible cause	Possible solution
The system does not recognize a USB device.	A USB extension cable is used.	Do not use a USB extension cable.
	A USB hub is used.	Do not use a USB hub.
	A USB device is rapidly connected to or disconnected from the USB connection port.	Slowly connect or disconnect the USB device.

10. Troubleshooting guide

BLUETOOTH® STREAMING AUDIO

Symptom	Possible cause	Possible solution
Registration cannot be performed.	The Bluetooth® audio device is not compatible with the in-vehicle audio system.	Check the Bluetooth® audio device Owner's Manual.
	Bluetooth® is disabled on device.	Check that the Bluetooth® function is enabled on device.
	The PIN code is incorrect.	Check the PIN code for the Bluetooth® audio device that is to be registered.
		Check that the PIN code for the Bluetooth® audio device is consistent with that for the in-vehicle audio system.
	Another Bluetooth® device is used in the vehicle.	Turn off the other Bluetooth® device until the registration is completed.
Music cannot be played back.	The Bluetooth® audio device is not compatible with the in-vehicle audio system.	Check the Bluetooth® audio device Owner's Manual.
	The system is not set to the Bluetooth® audio mode.	Switch to the Bluetooth® audio mode.  "Selecting audio source" (page 4-9)
	A Bluetooth® adapter is turned off.	Turn on a Bluetooth® adapter when it is used for a Bluetooth® audio device.
Playback stops.	The Bluetooth® audio device is not compatible with the in-vehicle audio system.	Visit www.nissanusa.com/bluetooth/ to check Bluetooth® audio device compatibility.
	A cellular call is active.	This is not a malfunction.
	Sound may cut out when a Bluetooth® audio device is operated.	Switch to the Bluetooth® audio mode, and then operate a function on the touch screen display of the in-vehicle system instead of conducting the operation on the Bluetooth® audio device.  "Selecting audio source" (page 4-9)

10. Troubleshooting guide

Symptom	Possible cause	Possible solution
Audio operation cannot be performed.	A Bluetooth® audio device that does not support audio operations is in use.	Visit www.nissanusa.com/bluetooth/ to check Bluetooth® audio device compatibility.
	An error occurs when connecting to a Bluetooth® audio profile.	Turn the power source of the Bluetooth® audio player off and on, and then resume connection with the system.

BLUETOOTH® HANDS-FREE PHONE SYSTEM

Symptom	Possible cause	Possible solution
A cellular phone cannot be registered.	The cellular phone is not compatible with the in-vehicle hands-free phone system.	Use a cellular phone compatible with the system. Visit www.nissanus.com/bluetooth/ to check compatibility.
	Registration of the cellular phone has been performed incorrectly.	Check the registration procedure, and then register the cellular phone again.
A cellular phone cannot be connected or is disconnected after the registration is completed.	The Bluetooth® setting of the in-vehicle hands-free phone system is turned off.	Turn on the Bluetooth® setting of the system.
	The Bluetooth® setting of the cellular phone is turned off.	Turn on the Bluetooth® setting of the cellular phone.
	The remaining battery level of the cellular phone is low.	Charge the battery of the cellular phone.
	The wireless Bluetooth® connection may be disrupted depending on the location of the cellular phone.	Do not place the cellular phone in an area surrounded by metal or far away from the in-vehicle hands-free phone system. Do not place the cellular phone close to the seats or your body.
	Registration of the cellular phone is not completed.	Perform registration of the cellular phone.
A call to a particular phone number fails.	If the system tries to make a call several times to the same phone number (for example: the party does not respond to the call, the party is out of the service area, or the call is abandoned before the party responds), the system may reject a request to make a call to the phone number.	Turn off the cellular phone and turn it on again to reset the connection.

10. Troubleshooting guide





Symptom	Possible cause	Possible solution
The system does not recognize the connection of a cellular phone. The system does not receive or make a call.	The cellular phone is not compatible with the in-vehicle hands-free phone system.	Use a cellular phone compatible with the system. Visit www.nissanusa.com/bluetooth/ to check compatibility.
	The cellular phone is not connected.	Check the registration procedure, and then register the cellular phone again.
	The phone operation is limited by the functions (such as dial lock, etc.) of the registered cellular phone.	Remove any settings that are limiting use of the cellular phone, and then perform registration again.
The other party cannot hear your voice. The other party can hear your voice, but it cracks or cuts out.	Mute function is enabled.	Verify mute function is disabled.
	The cellular phone is not connected.	Check the registration procedure, and then register the cellular phone again.
	The fan speed of the heater/air conditioner is too fast.	Decrease the fan speed of the heater/air conditioner.
	The ambient noise level is excessive. (For example: heavy rain, construction sites, inside a tunnel, oncoming vehicles, etc.)	Close the windows to shut out ambient noise.
	The noise generated by driving the vehicle is too loud.	Reduce the vehicle speed.
	The incoming or outgoing voice level is too loud.	Adjust the incoming or outgoing voice level properly.
The voice is cut out or noise is heard during a call.	The wireless Bluetooth® connection may be disrupted depending on the location of the cellular phone.	Do not place the cellular phone in an area surrounded by metal or far away from the in-vehicle hands-free phone system. Do not place a cellular phone close to the seats or your body.
When a cellular phone is operated to make a call, the hands-free function becomes unavailable.	Some models of a cellular phone do not switch to the hands-free mode when they are operated to make a call.	This is not a malfunction. Make a call again using the hands-free function.

10. Troubleshooting guide

Symptom	Possible cause	Possible solution
The other party's voice cannot be heard. There is no ring tone.	The volume level is set to the minimum.	Adjust the volume level.
	A cellular phone is not connected.	Check the registration procedure, and then register the cellular phone again.
Each volume level (ring tone, incoming voice or outgoing voice) is different.	Each volume level is not adjusted properly.	Adjust each volume level properly.
The antenna display is different between the navigation screen and a cellular phone screen. Making or receiving a call is unavailable even though the antenna display shows that it is possible to do so.	The antenna display varies depending on the model of cellular phone.	This does not indicate a malfunction. The antenna display and remaining battery level shown on the navigation screen may be different from those shown on the cellular phone screen. Use them as a reference.
A voice cannot be heard clearly when using a cellular phone behind tall buildings.	Some structures such as tall buildings, etc. may cause irregular reflection of radio waves or completely shut out radio waves that are used for cellular phones.	Move to a place without tall buildings.
Noise is heard when using a cellular phone under/near areas of elevated railroads, high voltage electric power cables, traffic signals, neon billboards, etc.	Electromagnetic waves that are generated from radio devices may adversely affect the cellular phone.	This is not a malfunction.
Noise is heard in the sound from the audio system while using a cellular phone.	Radio waves that are generated from a cellular phone may adversely affect the sound from the audio system.	This is not a malfunction.
Sound skips or stutters.	The cellular phone may have turned on the wireless LAN (Wi-Fi).	Turn off the wireless LAN (Wi-Fi).
Phonebook cannot be downloaded.	An error occurred during the phone pairing process.	Please delete the Bluetooth® pairing information from both the mobile phone and vehicle system before registering it again.
	Phone does not support phonebook download function.	Visit www.nissanusa.com/bluetooth/ to check compatibility.

10. Troubleshooting guide

NISSANCONNECT® EV AND SERVICES

Symptom	Possible cause	Possible solution
The system cannot connect to the Nissan Data Center.	A subscription for the NissanConnect® EV and Services has not been established.	For registration, please visit the NissanConnect® Website.
	The user ID and password are not entered.	
	The communication line is busy.	Try again after a short period of time.
	The vehicle is in a location where it is difficult to receive radio waves.	When the vehicle moves to an area where radio waves can be transmitted sufficiently, communication will be restored. When the icon on the display shows that the vehicle is inside the communication area, the system can be used.
	TCU (Telematics Control Unit) is not turned on.	If the icon does not show that the vehicle is inside the communication area despite the fact that the vehicle is in that location, contact the NissanConnect® EV and Services support line at 1-877-664-2738.
	Radio wave reception is not sufficient for TCU (Telematics Control Unit) operation.	When the vehicle moves to an area where radio waves can be transmitted sufficiently, communication will be restored. When the icon on the display shows that the vehicle is inside the communication area, the system can be used.
Some of the items that are displayed on the menu screen cannot be selected.	The vehicle is being driven and some menu items are disabled.	Stop the vehicle in a safe location and apply the parking brake before operating the menu screen items.  "Functions disabled while driving" (page 1-14)
Some parts of the screen are not displayed.	The vehicle is being driven and some menu items are disabled.	Operate the system after stopping the vehicle in a safe location and applying the parking brake.  "Functions disabled while driving" (page 1-14)
The system does not announce information.	The volume level is set to the minimum.	Adjust the volume level by operating <VOL/  > located on the control panel or < + >/< - > on the steering wheel while the system is announcing information.  "Control buttons and touch screen display" (page 1-2)



NAVIGATION

BASIC OPERATIONS



Symptom	Possible cause	Possible solution
No image is displayed.	The brightness is at the lowest setting.	Adjust the brightness of the display. ☞ "Display settings" (page 1-16)
	The display is turned off.	Push <*/> to turn on the display.
The volume of the voice guidance is too high or too low.	The volume is not set correctly, or the voice guidance setting is turned off.	Adjust the volume of the voice guidance or turn on the voice guidance setting. ☞ "Volume and Beeps settings" (page 1-17)
No voice guidance is available.	Voice guidance is not provided for certain streets (roads displayed in gray).	This is not a malfunction.
No map is displayed on the screen.	A screen other than a map screen is displayed.	Touch [Map] on the Launch Bar or push <MAP>.
The screen is too dim. The movement is slow.	The temperature in the interior of the vehicle is low.	Wait until the interior of the vehicle has warmed up.
Some pixels in the display are darker or brighter than others.	This condition is an inherent characteristic of liquid crystal displays.	This is not a malfunction.
Some menu items cannot be selected.	Some menu items become unavailable while the vehicle is driven.	Park the vehicle in a safe location, and then operate the navigation system.

10. Troubleshooting guide

VEHICLE ICON

Symptom	Possible cause	Possible solution
Names of roads and locations differ between 2D view and Birdview™.	This is because the quantity of the displayed information is reduced so that the screen does not become too cluttered. There is also a chance that names of the roads or locations may be displayed multiple times, and the names appearing on the screen may be different because of a processing procedure.	This is not a malfunction.
The location of the vehicle icon is misaligned from the actual position.	The vehicle was transported after the power switch was placed in the OFF position, for example, by a ferry or car transporter.	Drive the vehicle for a period of time on a road where GPS signals can be received.
	The position and direction of the vehicle icon may be incorrect depending on the driving environments and the levels of positioning accuracy of the navigation system.	This is not a malfunction. Drive the vehicle for a period of time to automatically correct the position and direction of the vehicle icon.  "Current vehicle location" (page 9-2)
	Driving with tire chains or tires that have been replaced may result in an incorrect vehicle location display due to miscalculation by the speed sensor.	Drive the vehicle for a period of time (at approximately 19 MPH (30 km/h) for about 30 minutes) to automatically correct the vehicle icon position. If this does not correct the vehicle icon position, contact a NISSAN certified LEAF dealer.
	The map data has a mistake or is incomplete (the vehicle icon position is always misaligned in the same area).	Updated road information will be included in the next version of the map data.
When the vehicle is traveling on a new road, the vehicle icon is located on another road nearby.	Because the new road is not stored in the map data, the system automatically places the vehicle icon on the nearest road available.	Updated road information will be included in the next version of the map data.  "How to order map data updates" (page 9-9)

10. Troubleshooting guide

Symptom	Possible cause	Possible solution
The screen does not switch to the night screen even after turning on the headlights.	The daytime screen was set the last time the headlights were turned on.	Set the screen to the night screen mode using  when turning on the headlights.  "Display settings" (page 1-16)
The map does not scroll even when the vehicle is moving.	The current location map screen is not displayed.	Touch [Map] on the Launch Bar or push <MAP> .
The vehicle icon is not displayed.	The current location map screen is not displayed.	Touch [Map] on the Launch Bar or push <MAP> .

10. Troubleshooting guide

ROUTE CALCULATION AND VISUAL GUIDANCE

Symptom	Possible cause	Possible solution
Waypoints are not included in the auto reroute calculation.	Waypoints that have been already passed are not included in the auto reroute calculation.	To go to that waypoint again, edit the route.
Route information is not displayed.	Route calculation has not yet been performed.	Set the destination and perform route calculation.
	The vehicle is not on the suggested route.	Drive on the suggested route.
	Route guidance is turned off.	Turn on route guidance.
	Route information is not provided for certain types of roads (roads displayed in dark green).	This is not a malfunction.
The auto reroute calculation (or detour calculation) suggests the same route as the one previously suggested.	Route calculations took priority conditions into consideration, but the same route was calculated.	This is not a malfunction.
A waypoint cannot be added.	Five waypoints are already set on the route, including ones that the vehicle has already passed.	A maximum of 5 waypoints can be set on the route. To go to 6 or more waypoints, perform route calculations multiple times as necessary.
The suggested route is not displayed.	Roads near the destination cannot be calculated.	Reset the destination to a main or ordinary road, and recalculate the route.
	The starting point and destination are too close.	Set a more distant destination.
	The starting point and destination are too far away.	Divide the trip by selecting one or two intermediate destinations, and perform route calculations multiple times.
	There are time restricted roads (by the day of the week, by time) near the current vehicle location or destination.	Select [Do Not Use Restriction Info] in the [Time Restricted Rd] setting.  "Route Settings" (page 3-47)
A part of the route is not displayed.	The suggested route includes narrow streets (roads displayed in gray).	This is not a malfunction.

10. Troubleshooting guide



Symptom	Possible cause	Possible solution
The part of the route that the vehicle has already passed is deleted.	A route is managed by sections between waypoints. If the vehicle passed the first waypoint, the section between the starting point and the waypoint is deleted (it may not be deleted depending on the area).	This is not a malfunction.
An indirect route is suggested.	If there are restrictions (such as one-way streets) on roads close to the starting point or destination, the system may suggest an indirect route.	Adjust the location of the starting point or destination.
	The system may suggest an indirect route because route calculation does not take into consideration some areas such as narrow streets (gray roads).	Reset the destination to a main or ordinary road, and recalculate the route.
The landmark information does not correspond to the actual information.	This may be caused by insufficient or incorrect map data.	Updated information will be included in the next version of the map data.  "How to order map data updates" (page 9-9)
The suggested route does not exactly connect to the starting point, waypoints or destination.	There is no data for route calculation closer to these locations.	Set the starting point, waypoints and destination on a main road, and perform route calculation.

10. Troubleshooting guide

VOICE GUIDANCE

Symptom	Possible cause	Possible solution
Voice guidance is not available.	Voice guidance is only available at certain intersections marked with  . In some cases, voice guidance is not available even when the vehicle makes a turn.	This is not a malfunction.
	The vehicle has deviated from the suggested route.	Go back to the suggested route or request route calculation again.
	Voice guidance is turned off.	Turn on voice guidance.
	Route guidance is turned off.	Turn on route guidance.
The guidance content does not correspond to the actual road conditions.	The content of voice guidance may vary, depending on the types of intersections at which turns are made.	Follow all traffic rules and regulations.

TRAFFIC INFORMATION



Symptom	Possible cause	Possible solution
Traffic information is not displayed.	Traffic information is not turned on.	Turn on the traffic information.
	The vehicle is in an area where traffic information is not available.	Scroll to an area where traffic information is available.
	The subscription to SiriusXM Traffic is incomplete, or the subscription to SiriusXM Traffic has expired.	Check the subscription status of SiriusXM Traffic.  "Notes on SiriusXM Traffic information" (page 6-8)
	The map scale is set at a level where the display of icons is impossible.	Check that the map scale is set at a level in which the display of icons is possible.  "Traffic information on map" (page 3-50)
With the automatic detour route turned on, no detour route is set to avoid congested areas.	There is no faster route compared to the current route, based on the road network and the traffic information.	The automatic detour search is not intended for avoiding traffic jams. It searches for the fastest route taking conditions such as traffic jams into consideration. Follow the current route.  "Notes on SiriusXM Traffic information" (page 6-8)
The route does not avoid a road section with traffic information stating that it is closed due to road construction.	The navigation system is designed not to avoid this event because the actual period of closure may differ from the declared roadwork period.	Observe the actual road conditions and follow the instructions on the road for a detour when necessary. If the road is closed, use the detour function and set the detour distance to avoid the road section that is closed.

10. Troubleshooting guide

VOICE RECOGNITION

Symptom	Possible cause	Possible solution
The system does not operate or fails to interpret the command correctly.	The interior of the vehicle is too noisy.	Close the windows or have the other occupants be quiet.
	The fan speed of the heater/air conditioner is too fast.	Decrease the fan speed of the heater/air conditioner.
	The noise generated by driving the vehicle is too loud.	Reduce the vehicle speed.
	The voice command is spoken in a low voice.	Speak the command in a louder voice.
	The timing of speaking a command is too early.	Speak the command after confirming the following: a voice guidance is announced, a tone sounds, and an icon on the screen changes from gray to orange.
	The command is spoken too slowly.	Speak in a natural voice without pausing between words.
The system prompts to repeat a command.	Pronunciation is unclear.	Speak clearly.
	The command is spoken too late after the tone.	Speak the command within 5 seconds after confirming the following: a voice guidance is announced, a tone sounds, and an icon on the screen changes from gray to orange.
	An improper command is spoken.	Speak the command or a number that is displayed on the screen. Speak a command that is shown in the command list.
The system does not correctly recognize a number spoken.	Too many numbers are spoken at once.	Place a pause between the appropriate digits for correct recognition by the system. When speaking a telephone number, place a pause between area codes, dial codes, etc.



10. Troubleshooting guide

Symptom	Possible cause	Possible solution
USB memory device cannot be operated with voice commands.	Depending on the device, iPhone® or iPod® may be recognized as a USB memory device.	This is not malfunction
	More than one audio device is connected to USB connection port.	Only one audio device can be operated with the voice recognition system even when multiple numbers of devices are connected. Select an audio source to operate with the voice recognition system.  "Voice recognition settings" (page 8-19)
The USB/iPod® operation screen is grayed out.	The audio device is not connected.	Connect an audio device to the system.
	An audio source to be operated with the voice recognition system has not been selected.	Select an audio source to be operated with the voice recognition system.  "Voice recognition settings" (page 8-19)
An error message is displayed when trying to select a track and operate USB/iPod®.	The track information is being processed for registration by the system.	Song information will be loaded into the system when a new audio device is registered for the first time or when the song information in the pre-registered device has been changed. Please wait for the loading to complete which may take a few minutes to up to an hour.
	Exceeding number of songs are stored in the connected audio device than it can hold.	Decrease the number of songs stored in the audio device.
	No song is stored in the audio device.	Store songs in the connected audio device. Storing songs with information such as artist name, album name, song name, playlist, etc., will make voice recognition song search available.
The system does not correctly recognize a Point of Interest (POI) name spoken.	There are some rare cases where a POI search is unavailable by speaking the facility name but the location can be found on the map.	This is not a malfunction. Consider using an alternate search method, like street address.

10. Troubleshooting guide



Symptom	Possible cause	Possible solution
The system does not correctly recognize a Point of Interest (POI) name spoken.	Partial or alias name is spoken.	For best results, speak the full name.

Apple CarPlay™ (if so equipped)

Symptom	Cause and Countermeasure
Cannot start Apple CarPlay™ though it is tethered to the vehicle.	The USB cable is not connected to the USB connection port. Properly connect the USB cable to the USB connection port.  "USB (Universal Serial Bus) Connection Port and AUX (auxiliary) input jack" (page 1-5)
	Use an Apple Lightning™ cable (Mfi certified) to connect your phone to the USB connection port and check the cable that is not broken.
	Apple CarPlay™ setting is not active on your iPhone®. Turn on "CarPlay" on your iPhone®.
	Device is not compatible with Apple CarPlay™. Check compatibility requirements.
Apple CarPlay™ performance decreases. For example, slow connectivity or slow application functionality. or An error message appears when trying to access features of Apple CarPlay™. A blank screen appears when trying to access maps.	Confirm you have a compatible iPhone®, a cellular connection and an active data plan.
	Use Apple Lightning™ cable (Mfi certified) to connect your phone to the USB connection port.
	Phone's performance or cellular connection. Disconnect and reconnect your phone.
Cannot access Siri® using the switch on the steering wheel.	Phone's performance or cellular connection. Cycle phone power off/on to restart.
	The USB cable may not be properly connected. Disconnect and reconnect the USB cable.
	Siri® setting is not enabled on the phone. Turn on "Siri" on your phone.
	Check that you are pushing and holding <  > instead of just pushing the switch to initiate Siri® operation.

10. Troubleshooting guide

Android Auto™

Symptom	Cause and Countermeasure
Cannot start Android Auto™ though it is connected to the vehicle.	The USB cable is not connected to the USB connection port. Properly connect the USB cable to the USB connection port.  "USB (Universal Serial Bus) Connection Port and AUX (auxiliary) input jack" (page 1-5)
	Always Start Android Auto™ setting is not active on your in-vehicle system. Turn on [Always Start Android Auto] on your in-vehicle system.  "Android Auto™ settings" (page 6-14)
	Touch [Smartphone Connection] or [Android Auto] on the MENU screen to activate Android Auto™.  "How to view and operate HOME MENU screen" (page 1-12)
	The connected device is not compatible with Android Auto™. Check the compatibility requirements.
	Your Android phone may not be recognized if its battery is low. Charge your Android phone then try again.
Android Auto™ performance decreases. For example, slow connectivity or slow application functionality. or An error message appears when trying to access features of Android Auto™. A blank screen appears when trying to access maps.	Confirm you have a compatible Android phone, a cellular connection and an active data plan.
	Use the Android phone OEM cable to connect your phone to the USB connection port.
	Phone's performance or cellular connection. Disconnect and reconnect your phone.
	Phone's performance or cellular connection. Cycle phone power off/on to restart.

10. Troubleshooting guide

Cannot start voice operation using the switch on the steering wheel.	The USB cable may not be properly connected. Disconnect and reconnect the USB cable.
	To use the voice operation function while driving, turn on the "While driving" setting on your Android phone.
	Check that you are pushing and holding <  > instead of just pushing the switch for voice operation.

10. Troubleshooting guide

MEMO

Number

2D map..... 3-4

A

About route guidance..... 3-31

Adjusting settings..... 1-11

Android Auto™..... 6-12

Apple CarPlay™..... 6-9

Audio main buttons..... 4-8

Audio operation precautions..... 4-2

Audio operations..... 4-9

AUX (auxiliary) input jack..... 1-5

Auxiliary (AUX) devices..... 4-25

B

Battery information..... 2-11

Birdview™ (3D) map..... 3-5

Bluetooth® Hands-Free

Phone System..... 7-2

Bluetooth® setting..... 7-13

Bluetooth® streaming audio..... 4-7, 4-22

Building graphics..... 3-6

C

Canceling Route..... 3-40

Changing map..... 3-10

Changing order of destination
and waypoints..... 3-42

Changing scale of map..... 3-9

Charge
recommendation guidance..... 2-11

Charging station information..... IT-2

Climate control & audio screen..... 1-9

Clock settings..... 1-17

Command list..... 8-6

Compatibility..... 6-12

Compressed Audio

Files (MP3/WMA/AAC)..... 4-6

Confirming route..... 3-40

Connecting Bluetooth®
audio device..... 1-18

Connecting Bluetooth® device..... 1-18

Connecting Bluetooth®

Hands-free Phone..... 7-4

Connecting cellular phone..... 1-18

Connecting to Interactive

Voice Menu..... 5-12

Control buttons and touch
screen display..... 1-2

Control panel..... 1-2

Current location map

menu screen..... 3-15

Current vehicle location..... 9-2

Customer assistance..... 10-2

D

Deleting stored item..... 3-57

Destination setting menu..... 3-16

Display settings..... 1-16

Displaying charging station icons
on map..... 2-5

Displaying current vehicle location.... 3-3

Displaying estimated driving range... 2-3

Displaying urgent
traffic information..... 3-50

Driving range..... IT-2

During a call..... 7-5

E

Editing route..... 3-40

Editing stored information..... 3-54

Emergency support..... 5-15

Energy usage
information display..... IT-3, 2-8

Error message on communication.... 5-21

F

Finding address..... 3-19

Finding charging station..... 3-19

Finding nearby place..... 3-21

Finding points of interest..... 3-21

Index

Functions disabled while driving..... 1-14

G

Giving voice commands..... 8-2

Google Maps..... 3-27

H

Hands-free text
messaging assistant..... 7-6

How to handle the Map SD card..... 9-9

How to handle the SD card..... 9-14

How to see voice command screen.... 8-3

I

Information feeds..... 5-12

Information menu..... 6-2

iPod® player..... 4-18

L

Laser product..... 0-6

Launch Bar..... 1-7

Liquid crystal display..... 9-13

Low Battery..... 2-11

M

Making a call..... 7-4

Map data..... 9-9

Map Menu screen..... 3-15

Map operation..... 3-3

Map symbols..... 3-7

Map types..... 3-3

Map view settings..... 3-11

Moving map..... 3-8

N

Navigation settings..... 3-60

Navigation Telematics..... IT-7

NissanConnect® EV and Services..... 5-1

Number input screen..... 1-11

O

One Shot Call..... 8-3

Operating with voice..... 6-13

Options before starting the
route guidance..... 3-29

P

Phone..... 7-4

Phone selection..... 7-4

Phone settings..... 7-10

Phonebook..... 7-12

Q

Quick Dial..... 7-12

R

Radio..... 4-2, 4-10

Recalculating route..... 3-43

Receiving a call..... 7-5

Route calculation..... 9-6

Route guidance..... 3-31, 9-8

Route guidance settings..... 3-44

Route menu..... 3-37

Route Planner..... 3-28

S

Safety information..... 0-3, 3-3

Scrolled location map screen..... 3-16

Searching for detour route using
traffic information..... 3-43

Searching from address book..... 3-24

Searching from
previous destinations..... 3-24

Setting at information on map..... 3-14

Setting by phone number..... 3-25

Setting city center..... 3-26
 Setting destinations by Google..... 3-27
 Setting detour route..... 3-44
 Setting freeway entrance/exit..... 3-26
 Setting from stored routes..... 3-26
 Setting home as destination..... 3-23
 Setting intersection..... 3-25
 Setting menu..... 1-15
 Setting new destination..... 3-40
 Setting point on map..... 3-28
 Setting with NissanConnect® EV
 and Services..... 3-28
 Siri®..... 6-10
 SiriusXM Travel Link..... 6-7
 Specifying region..... 3-18
 Split screen..... 3-10
 Starting system..... 1-6
 Start-up screen..... 1-6
 Steering wheel controls for audio..... 4-9
 Steering wheel switches..... 1-4
 Storing a location/route..... 3-52
 Storing avoid area..... 3-53
 Storing favorites..... 5-14
 Storing home location..... 3-52
 Storing location..... 3-52
 Storing route..... 3-53
 Subscription to NissanConnect® EV
 and Services..... 5-4

System settings..... 1-15

T

Telematics overview..... 5-2
 Telematics service..... IT-3
 Text message settings..... 7-10
 Touch panel..... 1-9
 Trademarks..... 0-4
 Traffic information on map..... 3-50
 Traffic information setting..... 3-51
 Transferring information to/from
 address book..... 3-58
 Turn list..... 3-36

U

Unique EV function settings..... 2-9
 Unique EV functions..... IT-2
 Updating charging
 station information..... 2-7
 USB (Universal Serial Bus)
 connection port..... 1-5, 4-3
 USB memory device care
 and cleaning..... 9-15
 USB memory device player..... 4-15

V

Viewing energy usage information..... 2-8
 Viewing from map menu..... 2-7
 Viewing NissanConnect®
 EV records..... 5-14
 Viewing SiriusXM Travel Link..... 6-7
 Viewing traffic events from list..... 3-49
 Viewing traffic information..... 3-49
 Voice Prompt Interrupt..... 8-3
 Voice recognition..... 8-2
 Voice recognition settings..... 8-19
 Volume settings..... 1-17

Z

Zero Emission menu screen..... 2-2

Index

MEMO

LEAF



Printing : April 2018
Publication No.: N18E 1ENJU1
Printed in the U.S.A.

ZE1-N